

3D PRINTING HANDBOOK

USER MANUAL FOR 3D PRINTERS:

- ORIGINAL PRUSA i3 MK3 KIT
- ORIGINAL PRUSA i3 MK3

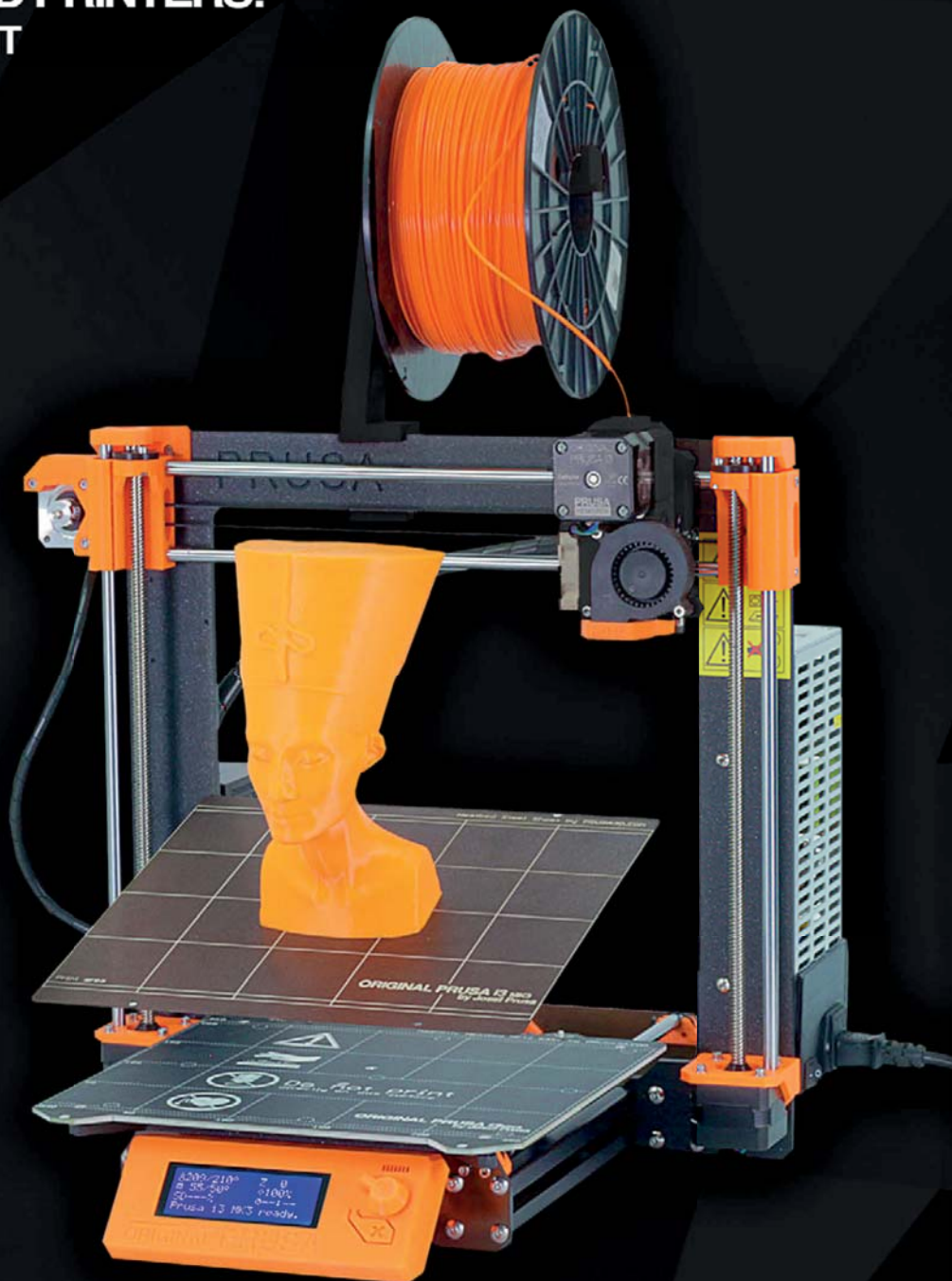

PRUSA
RESEARCH
by JOSEF PRUSA

PRUSA RESEARCH S.R.O.
Partyzánská 188/7A
170 00 Praha
www.prusa3d.com
info@prusa3d.com



Please always refer to the <http://www.prusa3d.com/drivers/> for an updated version of this 3D printing handbook (PDF download).

Translated versions of the handbook are available at:

Czech: www.prusa3d.cz/ovladace/

French: www.prusa3d.fr/drivers/

German: www.prusa3d.de/treiber/

Polish: pl.prusa3d.com/sterowniki/

Italian: www.prusa3d.it/driver/

Spanish: www.prusa3d.es/drivers-y-manuales/

QUICK GUIDE TO THE FIRST PRINT

1. Read the safety instructions carefully ([page 7](#))
2. Place the printer on a flat and stable surface ([page 10](#))
3. Download and install the drivers ([page 44](#))
4. Calibrate the printer by following our calibration flow / wizard ([page 11](#))
5. Insert the SD card into the printer and print your first model ([page 27](#))



Important notice, tip, hint or information that helps you print with ease.



Read carefully! This part of the text has the greatest importance - either for user safety or for proper printer service.



This symbol indicates text related to a printer kit only.

About the author

Josef Prusa (born Feb 23rd, 1990) became interested in the 3D printing phenomenon before joining Prague's University of Economics in 2009 - at first it was a hobby, a new technology open to changes and improvements. The hobby soon became a passion and Josef grew into one of the leading developers of Adrien Bowyer's international, open source, RepRap project. Today, you can see the Prusa design in different versions all around the world, it is one of the most popular printers and thanks to it, knowledge about the 3D printing technology significantly increased among the public.

Jo's work on self-replicating printers (you can print the other printer parts with your printer) still ongoing and currently, there is Prusa i3 MK3 - the third iteration of the original 3D printer. It is constantly updated with the latest innovations and you've just purchased its latest version. In addition to printer hardware upgrades, the main goal is to make the technology more accessible and understandable to all users.

Josef Prusa also organizes workshops for the public, participates in professional +++conferences dedicated to the popularization of 3D printing. For example, he lectured at the TEDx conference in Prague and Vienna, at World Maker Faire in New York, Maker Faire in Rome or at the Open Hardware Summit hosted by MIT. Josef also teaches Arduino at Charles University and was also a lecturer at the Academy of Arts in Prague.

In his own words, he imagines 3D printers will be available in every home in the not-too-distant future. "If anything is needed, you can simply print it. In this field, you just push the boundaries every day... We're glad you're part of it with us!"



Table of contents

2 Product details	6
3 Introduction - Glossary, Disclaimer, Safety instructions, Licenses	6
4 Original Prusa i3 MK3 printer	8
5 Original Prusa i3 MK3 printer kit	9
6 First steps	10
6.1 Printer unpacking and proper handling	10
6.2 Printer assembly	11
6.3 Setup before printing	11
6.3.1 Calibration flow and wizard	11
6.3.2 Flexible steel sheet surface preparation	13
6.3.3 Increasing the adhesion	16
6.3.4 Selftest (kit only)	16
6.3.4.1 Selftest error messages and resolution (kit only)	17
6.3.5 Calibrate XYZ (kit only)	18
6.3.5.1 Calibrate XYZ error messages and resolution (kit only)	19
6.3.6 Calibrate Z	20
6.3.7 Mesh bed leveling	21
6.3.8 Loading the filament into the extruder	22
6.3.8.1 Unloading the filament	23
6.3.9 First layer calibration (kit only)	24
6.3.9.1 Bed level correction (kit only)	25
6.3.10 Fine tuning the first layer	25
6.3.10.1 Print Prusa logo	25
6.3.10.2 Check probe height (kit only)	26
7 Printing	27
7.1 Removing objects from the printer	27
7.2 Printer Control	28
7.2.1 LCD screen	28
7.2.2 Controlling the LCD screen	28
7.2.3 Print statistics	29
7.2.4 Fail stats	29
7.2.5 Normal vs. Stealth mode	30
7.2.6 Factory reset	30
7.2.7 SD card sorting	30
7.2.8 Testing if file (.gcode) is complete	31
7.2.9 LCD layout	32
7.2.10 Print speed versus print quality	34
7.2.11 USB cable and Pronterface	34
7.2.12 Power panic	36
7.2.13 Crash detection	37
7.2.14 Temperatures	37
7.2.15 Voltages	37
7.2.16 Safety timer	37
7.2.17 Beeper settings	37
7.2.18 Language settings	38
7.3 Printer addons	38
7.3.1 Different nozzles	38
7.3.2 Original Prusa Multi Material Upgrade 2.0	39
	4

7.3.3 Connecting Raspberry Pi Zero W	40
8 Advanced Calibration	41
8.1 PID tuning for Hotend (Optional)	41
8.2 P.I.N.D.A. probe calibration / Temp. calibration (Experimental/Optional)	41
8.3 View XYZ calibration details (Optional)	42
8.4 Linear Advance (Experimental)	42
8.5 Extruder info	43
9 Printer drivers	44
10 Printing your own models	44
10.1 Where can you get the 3D models?	44
10.2 In what program can you create your own models?	44
10.3 PrusaControl	45
10.4 Slic3r Prusa Edition	46
10.5 Bundled 3D models	48
10.6 Print in color with ColorPrint	48
10.7 Printing of non-standard models	51
10.7.1 Printing with support material	51
10.7.2 Large object printing	52
11 Materials	53
11.1-11.11 ABS, PLA, PET, HIPS, PP, Nylon, Flex, Composite materials, ASA, nGen, PC-ABS	53
11.12 Dialing in new materials	60
12 FAQ - Printer maintenance and print issues	61
12.1 Regular maintenance	61
12.1.1 Bearings	61
12.1.2 Fans	61
12.1.3 Extruder drive gear	62
12.1.4 Electronics	62
12.1.5 PEI rejuvenation	62
12.2 Print surface preparation	62
12.3 Filament sensor	62
12.3.1 Running out of filament	63
12.3.2 Filament jam	63
12.3.3 False sensor readings and debugging	64
12.4 Clogged / jammed extruder	65
12.5 Nozzle cleaning	66
12.6 Replacing / changing the nozzle	66
12.7 Printing problems	69
12.7.1 Layers break and split when printing from ABS material	69
12.7.2 Models contain either too much or not enough of the filament	69
12.8 Problems with finished models	69
12.8.1 Model breaks and/or is easily damaged	69
12.9 Updating printer firmware	69
12.10 Linearity correction	71
13 FAQ - common issues when assembling the printer kit	71
13.1 Printer is rocking - YZ frame - geometry check	71
13.2 Printer stops printing soon after start	72
13.3 Printer can't read the SD card	72
13.4 Loose X- and/or Y-axis belts	73
13.5 Cables detached from the heatbed	74
14. FAQ - Error messages	74

2 Product details

Title: Original Prusa i3 MK3 / Original Prusa i3 MK3 (kit), Filament: 1.75 mm
Manufacturer: Prusa Research s.r.o., Partyzánská 188/7A, Prague, 170 00, Czech Republic
Contacts: phone +420 222 263 718, e-mail: info@prusa3d.com
EEE group: 3 (IT and/or telecommunication equipment), Device use: indoor only
Power supply: 90-135 VAC, 2 A / 180-264 VAC, 1 A (50-60 Hz)
Working temperature range: 18 °C (PLA)-38 °C, indoor use only
Working humidity: 85 % or less



Kit weight (gross / net): 9.8 kg / 6.3 kg, assembled printer weight (gross / net): 12 kg / 6.3 kg.
The serial number is located on the printer frame and also on the packaging.

3 Introduction

Thank you for purchasing 3D printer **Original Prusa i3 MK3** from Josef Prusa either as an assembled printer or a printer kit - your purchase supports us with its further development. Please, read the handbook carefully, since all chapters contain valuable info for the correct service of the printer. **Original Prusa i3 MK3** is a successor to Original Prusa i3 MK2S with numerous hardware and software upgrades, which lead to improved reliability, increased print speed as well as ease of use and assembly.

Please check the <http://prusa3d.com/drivers> page for the updated version of this 3D printing handbook (PDF download).

In case of any printer-related problem, do not hesitate to contact us at info@prusa3d.com. We are glad to receive all of your valuable comments and tips. We strongly suggest you visit our official forum at forum.prusa3d.com, where you can find solutions to common issues, tips, advice and hints, in addition to actual information about the Original Prusa i3 printer's development.

3.1 Glossary

Bed, Heatbed, Printbed - Commonly used term for the printing pad - a heated area of the 3D printer where 3D objects are printed.

Extruder - The printing head also known as extruder, is a part of a printer consisting of a nozzle, hobbed pulley, idler, and a nozzle fan.

Filament - The term for plastic provided on a spool. It's used throughout this handbook as well as in the LCD menu on the printer.

Heater, Hotend - Other names for a printing nozzle.

1.75 - 3D printers use two different diameters (thickness) of filament : 2.85 mm (commonly called as 3 mm) and 1.75 mm. Worldwide, the 1.75mm version is used more, although there is no difference in printing quality.

3.2 Disclaimer

Failure to read the handbook may lead to personal injury, inferior results, or damage to the 3D printer. Always ensure that anyone who operates the 3D printer knows and understands the contents of the Manual. We cannot control the conditions in which you assemble the Original Prusa i3. For this, and other reasons, we do not assume responsibility, and expressly disclaim liability for loss, injuries, damage, or expense arising out of, or in any way connected with, the assembly, handling, storage, use or disposal of the product. The information in this handbook is provided without any warranty, expressed or implied, regarding its correctness.

3.3 Safety instructions



Please be very cautious during any interaction with the printer. This printer is an electrical device with moving parts and hot-temperature areas.

1. The device is for indoor use only. Do not expose the printer to rain or snow. Always keep the printer in a dry environment at a minimum distance of 30 cm from other objects.
2. Always place the printer on a stable place, where it cannot fall or tip over.
3. The printer supply is household power outlet 230 VAC, 50 Hz or 110 VAC / 60 Hz. Never connect the printer to a different power supply; it may cause malfunction or damage to the printer.
4. Place the power cord so you cannot stumble on it or step on it, or otherwise expose it to any potential damage. Also make sure that the power cord is not mechanically or otherwise damaged. If so stop using damaged power cord immediately, and replace it.
5. When you disconnect the power cord from the socket, pull the plug rather than the cord to reduce the risk of damage to the plug or to the AC outlet.
6. Never disassemble the printer power supply; it does not contain any parts that could be repaired by an unskilled worker. All repairs must be performed by a qualified technician.
7. Do not touch the nozzle or heatbed when the printer is printing or warming up. Note that the temperature of the nozzle is 210-300 °C (410-572 °F); heatbed temperature can reach over 100 °C (212 °F). Temperatures above 40 °C (104 °F) can cause harm to the human body.
8. Do not reach inside the printer while it is still in operation. An injury may be caused by its moving parts.
9. Prevent children from unsupervised access to the printer even when the printer is not printing.
10. Do not leave the printer unattended while it's still on!
11. Plastic is being melted during printing which produces odors. Set up the printer in a well-ventilated place.

3.4 Licenses

The Original Prusa i3 MK3 printer is a part of the RepRap project, the first open source 3D printer project free to use under a GNU GPL v3 license (www.gnu.org/licenses/gpl-3.0.en.html). If you improve, or alter any part of, a printer, and you are willing to sell, then you have to publish the source code under the same license. All 3D-printed elements of the printer that can be improved upon can be found at <http://www.prusa3d.com/prusa-i3-printable-parts/>.

4 Original Prusa i3 MK3 printer

Unlike the printer kit, the printer comes completely assembled and almost ready to print. After plugging in, and running the necessary calibration, you can print a 3D object in a matter of minutes after unpacking the printer. Keep in mind, you can use our support email when you purchase the assembled printer. Do not hesitate to write us if you need any advice or help. We will gladly help with any specific prints.

 3D printers use two different diameters of filament: 2.85 mm and 1.75 mm (you can find more in the chapter *Materials*). The 1.75mm version is used more worldwide, although there is no difference in printing quality. The filament is provided on a spool where you can find the basic information - filament maker, material (ABS, PLA, etc.) and filament diameter. 2.85 mm filament is commonly called 3 mm.

This printer supports only a 1.75 mm filament. Please check that the filament diameter is 1.75 mm before inserting it into the extruder. Do not try to insert wider filament; it could damage the extruder.

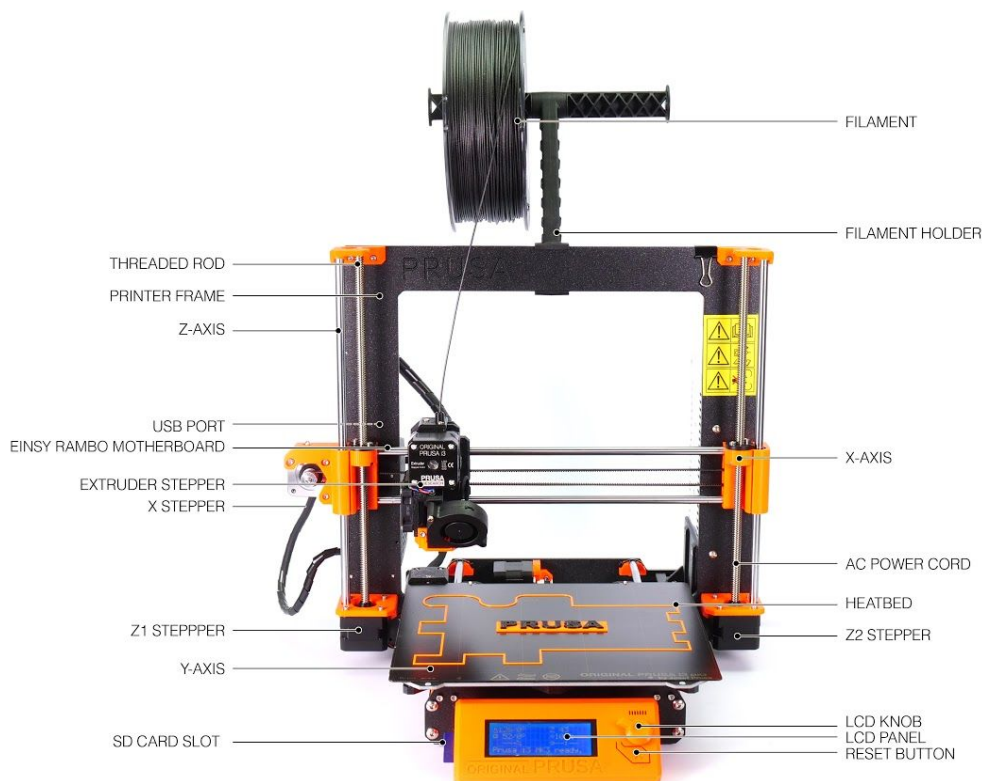

Pict. 1 - Original Prusa i3 MK3 printer description

5 Original Prusa i3 MK3 printer kit



Original Prusa i3 MK3 kit is shown in pict. 2. Detailed information and assembly description can be found in chapter [6.2 Printer assembly](#). We offer tech support for users who purchased the printer kit through our official forum. If you need help, do not hesitate to visit our forum at forum.prusa3d.com. You can find the answers to your problem there. If not, please just post your question directly there.



Pict. 2 - Original Prusa i3 MK3 printer kit unboxed

6 First steps

6.1 Printer unpacking and proper handling

While holding the upper frame, take the printer and pull it out from the box. Be careful when handling the printer not to damage the electronics and thus the proper printer functionality. Anytime you move the printer, always hold the upper frame with hotbed upright pointing away from you as pictured in pict. 3. When unpacking **the fully assembled version**, remove the top foam from the box and gently lift the printer up. Parts of the printer are secured by more foam which needs to be removed. Some parts are additionally secured with the white zip-ties, cut those off too.



Pict. 3 - Proper handling of the printer

Both the assembled version and the kit version come with a few things you might need during the printer use.

- **USB Cable** - used for uploading new firmware or alternatively printing from the computer.
- **Acupuncture needle** - used for cleaning a clogged nozzle. See the chapter [12.5 Nozzle cleaning](#) for more information.
- **Glue stick** - Used for better adhesion of Nylon, or as a separator for Flex materials. See the chapter [11 Materials](#) for more information.
- **Test protocol** - All the components of every printer are tested. The electronic parts are connected (as in a final assembly) and a battery of tests is run. The serial number stickers and the test protocol are printed only when the components pass all of the tests. The test protocol lists all the test results.

6.2 Printer assembly



For the Original Prusa i3 MK3 printer kit, we suggest following the guidelines and assembling the kit according to the online manual at manual.prusa3d.com. (The online manual is available in several languages on the website). The construction of the printer should not take more than one working day. After a successful completion, continue to the chapter [6.3 Setup before printing](#).

6.3 Setup before printing

- Place the printer in a horizontally stable position; the best place is a workbench where there is no risk of draft.
- Attach the filament holders to the upper frame.
- Attach a spool of **Filament** to the holders. Make sure the filament spool doesn't jam and can move freely.
- Plug in the AC power cord and turn on the switch.
- Check out the firmware version (in the Support menu via LCD panel) and please upgrade to the latest one from our website www.prusa3d.com/drivers.



Filament is a common term for the **plastic rod** - material provided on a spool from which 3D objects are printed.

6.3.1 Calibration flow and wizard

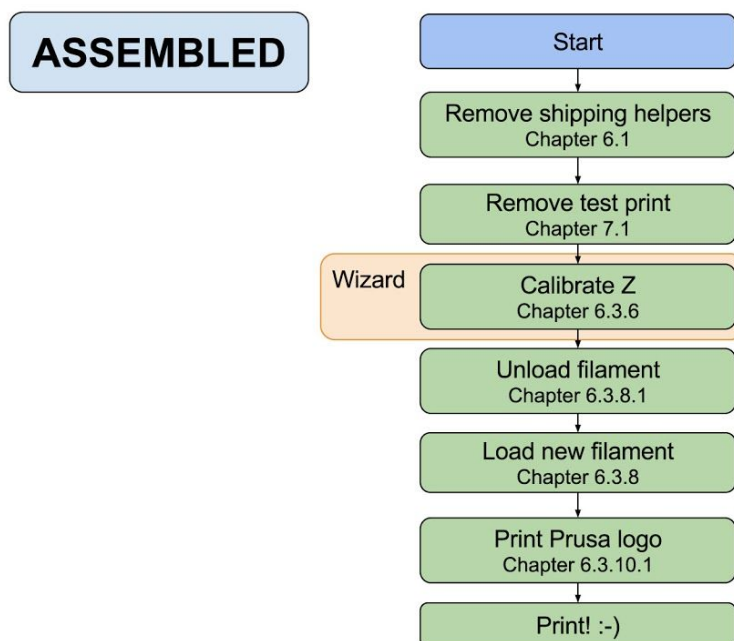

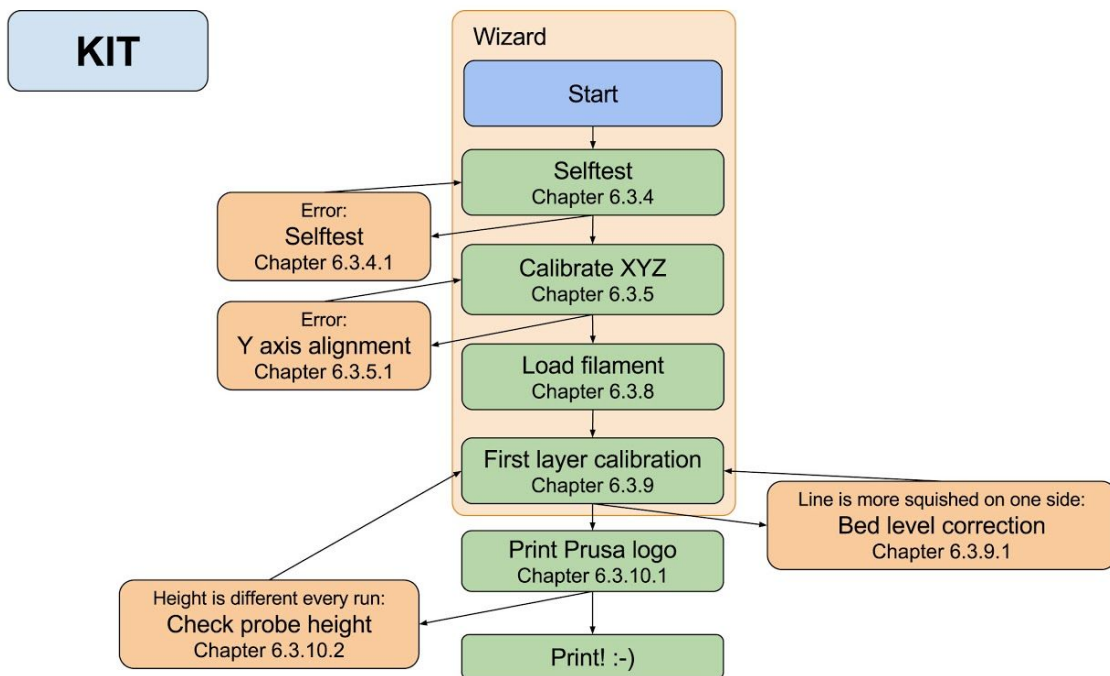

With your first start-up of your freshly-assembled printer, it will guide you through all the tests and calibrations you need to do to get started printing.

The Wizard can be also started manually from **LCD menu - Calibration - Wizard**. Do not forget to read chapter [6.3.2 Flexible steel sheet surface preparation](#) before running the Wizard.

It follows the calibration flow and helps you with the following steps:

- **Selftest** - [Chapter 6.3.4](#)
- **Calibrate XYZ** - [Chapter 6.3.5](#)
- **Loading the filament** - [Chapter 6.3.8](#)
- **First layer calibration** - [Chapter 6.3.9](#)

It is not mandatory to use it, and you can cancel the Wizard at the beginning. Then you should just follow the calibration flow manually.

First, I will run
the selftest to
check most common
assembly problems. ✓

Pict. 4 - Wizard setup

There are few special occasions where you will need to redo the calibration or a part of it.

- **Firmware update** - A complete guide is in the chapter [12.9 Updating printer firmware](#).
- **Readjusting the PINDA probe** - Run [6.3.6 Calibrate Z](#) to store new reference Z height values.



It is important to disconnect the printer USB from any computer or OctoPrint running on Raspberry Pi for the whole calibration because during the calibration, the printer will not respond to any request from a host connected via USB, and communication will time out. Such a time out would cause the host to reset the connection, causing the printer to restart (in the middle of calibration) and it might end up in a weird state requiring [7.2.6 Factory Reset](#).

6.3.2 Flexible steel sheet surface preparation

The MK52 heatbed has embedded high curie temperature magnets. These magnets are able to firmly hold removable spring steel sheets. There are two pins at the end of the heatbed that will align perfectly with cut out slots in the spring steel sheets. Make sure the bed is clean and there isn't any debris on it **before you put on the steel sheet. Never print directly on the heatbed.**

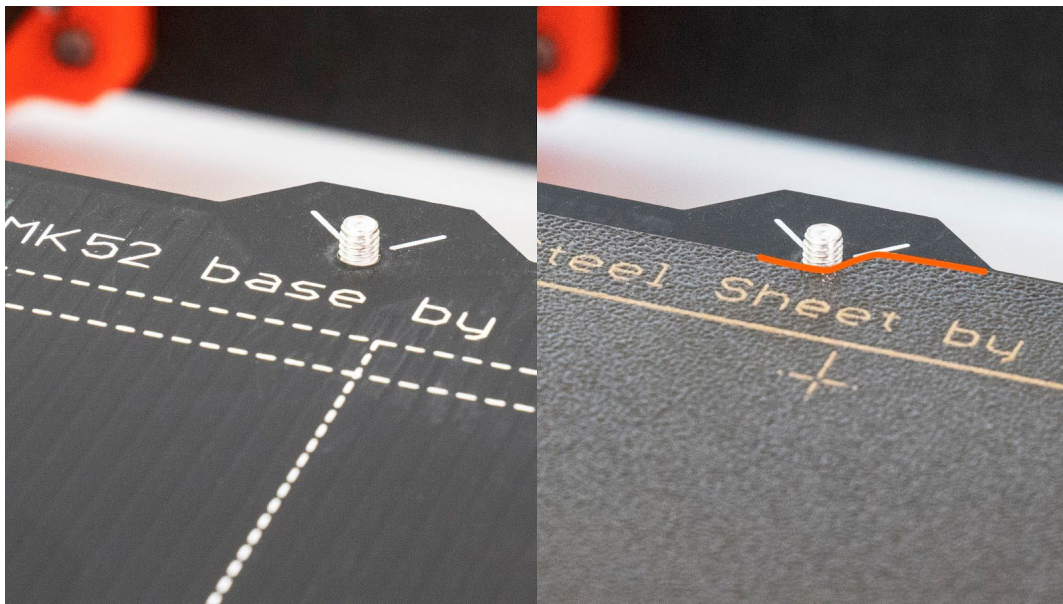

Pict. 5 - HeatBed MK52 base and powder coated steel sheet surface

To achieve the best adhesion on the new surface, it is important to keep the surface clean. Cleaning the surface is very easy. The best option is **Isopropyl alcohol** available in drugstores which is the best for ABS, PLA and others (except for PETG where the adhesion may be too strong. See the chapter [11.3 PET](#) for instructions). Pour a little amount on unscented paper towel and wipe the print surface. The bed should be cleaned while cold for the best results but it can also be cleaned when already preheated for PLA, just be careful

not to touch the bed surface or the nozzle. When cleaning at higher temperatures, the alcohol will evaporate before it can clean anything. Alternatively, you can clean the bed with **warm water and a few drops of a dish soap** on a paper towel. **Denatured alcohol** is yet another option.

 Calibration might be slightly different for different steel print sheets as the coating thickness varies. It is a good practice to check the first layer and adjust accordingly with **Live adjust Z** when switching between different types of steel sheets.

 The surface does not have to be cleaned before every print! It is just important to **not touch** the steel sheet with **your hands** or **dirty tools**. **Clean your tools with the same solution** as you would the sheet and you will be able to start your next print right away.



Pict. 6 - Steel print sheets - smooth PEI sheet and textured powder-coated PEI

 All original print surfaces from Prusa Research are coated from both sides.



Pict. 7 - Smooth PEI sheet (top) vs textured powder coated PEI (bottom) effect on first layer

6.3.2.1 Double-sided textured PEI powder-coated spring steel sheet

Powder coating directly on metal makes it very hard to damage this build plate. If a heated nozzle crashed into it, the metal can dissipate the heat. Powder coating also gives the surface a distinct textured look that will be visible on your prints.

The textured surface hides most of the mechanical damage caused by tools. Only the top of the small bumps can be scratched, which will not imprint on the bottom of the model.

This surface is used on our print farm, look at the printed parts you have on your printer for reference.

6.3.2.2 Spring steel sheet with smooth double-sided PEI

Uses the same PEI sheets as on the MK2/S.

You can leave small marks on the print surface with your nozzle or tools, they will typically be shinier than the rest. It does not affect the functionality or adhesion. However, if you want to have the same surface look on the whole printbed you can resurface it. The easiest way is to take the hard side of a dry kitchen sponge and gently wipe the affected area with a circular motion a few times.



The industrial glue which holds the PEI sheet on the heatbed itself softens when temperatures greater than 110 °C are used. If higher temperatures are used, the glue can migrate under the PEI and create slight bumps on the surface.

6.3.2.3 Aftermarket sheets

As MK3 is fully open source, we expect other manufacturers to manufacture compatible aftermarket sheets. Look for references online before buying them, or check with our online support.



Sheets must be coated from both sides! If only one side is coated, the metal edge on the bottom side can damage the heated bed surface when the protective lacquer is scratched off.

6.3.3 Increasing the adhesion

In some special occasions, such as a tall object with a very small contact area with the print surface, you might need to increase the adhesion. Fortunately, PEI is a very chemically resistant polymer and you can temporarily apply other adhesion solutions without damaging it. This also applies to materials which would not stick to PEI otherwise, like Nylon etc.

Before applying anything to the bed, consider using **Brim option** in Slic3r PE or PrusaControl which increases the surface area of the first layer.

For Nylon blends, a simple glue stick does the trick. The glue can be easily removed later either by a window cleaner or dish soap water.

For ABS prints, ABS juice can be used and later cleaned with pure acetone. Be very gentle when applying the juice and do so while the bed is cold. Prints will attach very strongly.



Prepared juice can also be purchased in our e-shop. Unfortunately, UPS service does not allow us to deliver any acetone-based products due to shipping constraints. In that case you get only the bottle and ABS from our e-shop and you have to source the acetone locally.

6.3.4 Selftest (kit only)

The purpose of the selftest routine is to check most common errors when assembling and connecting electronics and to help indicate any possible errors after the assembly. You can run the **Selftest** from **Calibration** menu on LCD panel. This should not be necessary on the assembled printers as those are pretested.

Initiating this routine performs a series of tests. The progress and results of each step are displayed on the LCD. In case of errors found, the selftest is interrupted and the reason for the error is shown to guide users in troubleshooting.



The selftest is just a diagnostic tool, the printer will still attempt to print even after the test fails. If you are absolutely certain that the affected part is correct, you may continue with the print process.

The test consists of

- **Extruder and print fan** test
- **Heatbed** and **hotend** proper wiring
- **XYZ motors** proper wiring and functionality
- **XY axis** length
- **XY belts** tension

- **Loose belt pulley test**
- **Filament sensor test**

6.3.4.1 Selftest error messages and resolution (kit only)

Front print fan/ Left hotend fan - Not spinning:

Check proper wiring of the print and the hotend fan cables. Ensure that both are properly connected to the EINSY electronics, and that they are not swapped.

Please check/ Not connected - Heater/ Thermistor:

Check proper wiring of the hotend power cables and the thermistor cables. Ensure that both are properly connected to the EINSY electronics, and that they are not swapped.

Bed/Heater - Wiring error:

Check that the heatbed and the hotend power cables are not swapped or that the thermistor cables from both the hotend and the heatbed are not swapped in the EINSY electronics.

Loose pulley - Pulley {XY}:

The belt pulley is loose and slips on the motor shaft. It is important to tighten the first grub screw on the flat piece of the shaft, then continue with the second grub screw.

Axis length - {XY}:

The printer measures the length of the axis by moving the print head from end to end twice. If the measured value is different from the physical length, your print head might be blocked from moving all the way. Check by hand if the print head moves smoothly when the printer is powered off.

Endstops - Wiring error - Z:

Check the proper cabling of the PINDA probe. Routine indicates the PINDA probe has a malfunction or is not properly responding. Check for the proper connection in the EINSY electronics.

Endstop not hit - Motor Z:

Check if the print head can be moved all the way down the Z axis to trigger the PINDA probe over the bed.

Please check: Filament sensor - Wiring error:

Check the wiring of the filament sensor cable for any damage. Ensure that one end is connected to the filament sensor and the other one to the correct slot on the EINSY board.

6.3.5 Calibrate XYZ (kit only)



The Original Prusa i3 MK3 comes with a full mesh bed leveling feature, however, for this to work, we need to first calibrate the distance between the tip of the nozzle and the PINDA (**Prusa INDuction Autoleveling**) probe.

The process is fairly straightforward; so let's get to it.

The purpose of the X/Y/Z calibration routine is to measure the skew of the X/Y/Z axes and to find the position of the 4 calibration points on the print bed for proper bed leveling. You can run the **XYZ calibration** from the **Calibration** menu on the LCD panel. This should not be necessary on the assembled printers as those are factory calibrated.

Place a sheet of a regular office paper (for example, the checklist shipped with every order) and hold it under the nozzle during the first round (first 4 points being checked) of calibration. If the nozzle catches on the paper during the process, power off the printer and lower the PINDA probe slightly. See the PINDA probe response diagram in [6.3.10.2 Check probe height](#). The paper will not affect the calibration process. The nozzle must not touch the print surface or deflect the bed by any means. If everything went correctly, continue with the calibration process.

Initiating this routine performs a series of measurements in three rounds: In the first round, **without the steel sheet installed**, 4 sensor points on the print bed are searched for carefully, so as not to touch the print bed with the nozzle. In the second round, the point locations are being improved. In the last round, **with the steel sheet on**, the height above the 9 sensor points is measured and stored in nonvolatile memory for reference. This finishes the Z axis calibration.

At the start of the XYZ calibration procedure the printer homes the X and Y axis. After that, the Z axis will begin to move up until both sides touch the printed parts at the top.

Please make sure the print head went all the way up the Z axis and that you heard a rattling sound as the Z stepper motors skip steps. This procedure ensures, that 1) the X axis is perfectly horizontal, 2) the print nozzle is in a known distance from the print bed. If the print head did **not** touch the end stoppers at the top of the Z axis, the printer could not possibly know the distance the print nozzle is from the print bed and it could, therefore, crash into the print bed during the first round of the X/Y calibration procedure.

The printer also checks the temperature of the PINDA probe.

The XYZ calibration procedure also prompts you to **"Please clean the nozzle for calibration. Click when done."**

If this advice is not followed and there is plastic debris on the print nozzle, then the debris may touch the print bed or even push the print bed away from the PINDA probe, so the PINDA probe will not trigger properly and the calibration will fail.

Starting with firmware 3.4.0, you can check the status of the P.I.N.D.A. probe in **LCD Menu - Settings - PINDA status**.

After the calibration is passed, the values can be reviewed for tweaking later. If you have the axes **perpendicular** or **slightly skewed**, nothing needs to be tweaked because the printer will perform with the best accuracy. Learn more in chapter [8.3 View XYZ calibration details \(Optional\)](#) under [8 Advanced calibration](#).

6.3.5.1 Calibrate XYZ error messages and resolution (kit only)

1) ***XYZ calibration failed. Bed calibration point was not found.***

The calibration routine did not find a bed sensor point. The printer stops close to the bed point, which it failed to detect. Please verify, that the printer is assembled correctly, that all axes move freely, the pulleys do not slip and the print nozzle is clean. If everything looks good, re-run the X/Y calibration and verify, with a sheet of paper between the nozzle and the print bed, that the print nozzle does not touch the print bed during the calibration routine. If you feel a friction of the nozzle against the sheet of paper and the nozzle is clean, you need to screw the PINDA probe slightly lower and re-run the X/Y calibration.

2) ***XYZ calibration failed. Please consult the manual.***

The calibration points were found in positions far from what should be expected from a properly assembled printer. Please follow the instructions of case 1).

3) ***XYZ calibration ok. X/Y axes are perpendicular. Congratulations!***

Congratulations, you built your printer precisely; your X/Y axes are perpendicular.

4) ***XYZ calibration all right. X/Y axes are slightly skewed. Good job!***

Good job, the X/Y axes are not precisely perpendicular, but still quite all right. The firmware will correct for the X/Y skew during normal printing, so boxes will be printed with right angles.

5) ***XYZ calibration all right. A skew will be corrected automatically.***

You may consider to re-align the X/Y axes (as described in the chapter [6.3.5.1 Y axis alignment](#)). Still the firmware will correct the skew during normal printing and as long as the X and Y axes move freely, the printer will print correctly.

During the mesh bed leveling procedure, the following errors may be reported on the display.

1) ***Bed leveling failed. Sensor disconnected or cable broken. Waiting for reset.***

Verify, whether the PINDA probe cable is plugged into the EINSY RAMBo board correctly. If that is the case, the PINDA probe is broken, and it needs to be replaced.

2) ***Bed leveling failed. Sensor didn't trigger. Debris on nozzle? Waiting for reset.***

This is a safety check to avoid crashing the nozzle into the print bed if the PINDA sensor stops working or something goes wrong with the printer mechanics (for example, a pulley slips). This safety check may also be triggered if the printer has been moved to an uneven surface. Before doing anything else, make the Z axis level by going all the way up and try again.

At the end of the X/Y calibration, the printer measures the reference height above each of the 9 bed sensor points and stores the reference heights in nonvolatile memory. During normal bed leveling, it is expected that the PINDA probe triggers no more than 1 mm from the reference value, therefore the nozzle is not allowed to move more than 1 mm below the reference value during the bed calibration.

If you moved the printer, you may need to re-run the Z calibration to sample new reference Z height values reflecting the twist and bend of the table surface the printer is sitting on. If that does not help, please verify, that the PINDA probe is aligned with the sensor points on the print bed during the bed Z calibration. The alignment shall be ensured by the automatic X/Y calibration routine. If the PINDA probe is not aligned during the Z calibration over time, it is possible, that a pulley is slipping or something on the machine's frame got loose.

3) ***Bed leveling failed. Sensor triggered too high. Waiting for reset.***

Similar to case 2). This time the PINDA sensor triggered more than 1 mm above the reference height. Before doing anything else, make the Z axis level by going all the way up and try again.

6.3.6 Calibrate Z

Calibrate Z is located in the **LCD Menu - Calibration - Calibrate Z**. It is always done with **the steel sheet on**. It should be performed whenever you move the printer to a different location. It saves the heights of all 9 calibration points in nonvolatile memory. Stored information is used every time mesh bed leveling is called during a print. When the measured values are vastly different from the stored values, the print is canceled because it is a good indicator something is wrong. Calibrate Z is a part of the routine Calibrate XYZ so there's no need to run it after a successful Calibrate XYZ.

It is a good practice to run this procedure every time you travel with the printer or the printer is shipped the geometry might change slightly and cause an error.

At the start of the Z calibration procedure the printer homes X and Y axis. After that, Z axis will begin to move up until both sides touch the printed parts at the top.

Please make sure the Z axis went all the way up and you heard a rattling sound as the Z stepper motors skip steps. This procedure ensures, that 1) the X axis is perfectly horizontal, 2) the print nozzle is in a known distance from the print bed. In case the Z carriage did **not** touch the end stoppers, the printer could not possibly know the height of the print nozzle above the print bed and it could therefore crash into the print bed during the Z calibration procedure.

The Z calibration procedure also prompts you to ***"Please clean the nozzle for calibration. Click when done."***

If this advice is not followed and there is a plastic debris on the print nozzle, then the debris may touch the print bed or even push the print bed away from the PINDA probe, so the PINDA probe will not trigger properly and the calibration will fail.

6.3.7 Mesh bed leveling

Mesh bed leveling can be found in **LCD Menu - Calibration**. It is the same procedure which is performed before every print. It is also the same procedure that happens in the second round of XYZ calibration.

The PINDA probes 9 points in a grid manner on the sheet plate (whether it is powder coated or smooth PEI does not matter) and measures the distance to the sheet. These points are interpolated and used to create a virtual mesh of the bed. During printing, if the bed is slightly warped, the probe will still precisely follow the surface according to its measured mesh. The deviation limit for the compensation is $\pm 50\mu\text{m}$ (or 0.05 mm).

The StallGuard for Z axis is active during the mesh bed leveling. In case the nozzle crashes into the bed before the PINDA probe triggers, the calibration process is interrupted and the user is asked to check if there is any kind of debris on the nozzle.

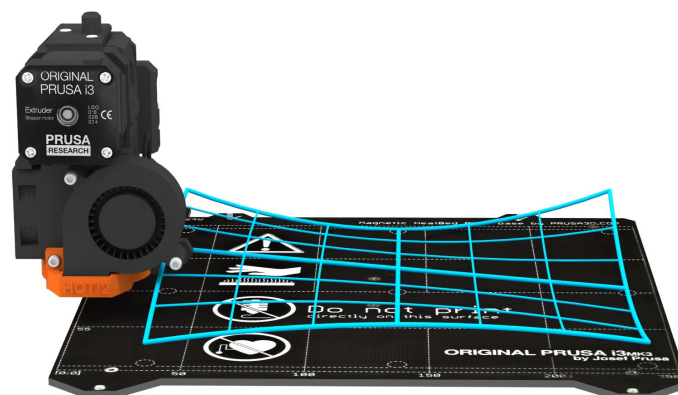

Pict. 8 - Visualisation of mesh bed leveling

6.3.8 Loading the filament into the extruder

Before you can load the filament, you have to preheat the printer for the correct filament type.

1. Press the control knob to enter the main menu on the LCD.
2. Rotate the control knob to choose **Preheat** option and confirm by pressing the control knob. Next you choose the material you will print from.
3. Wait for the nozzle to reach target preheat temperature

If you have **the filament sensor and autoloading enabled**, simply insert the filament into the extruder. Everything is automated from this point. Make sure that the filament tip is nice and pointy. Starting with firmware 3.3.1, the Z-axis will rise in case the current Z coordinate is less than 20mm from the print bed. This will ensure that there is always enough space for cleaning the nozzle.

If you have the filament sensor or autoloading disabled in the settings, you can manually start the loading process from the LCD menu.

1. Press the control knob on the LCD panel to enter the main menu.
2. Insert the filament into the extruder
3. Choose the **Load filament** option in the menu and press the button to confirm
4. The filament is then loaded to the extruder by the extruder stepper automatically.

You should cut the top of the filament as shown in the next picture.

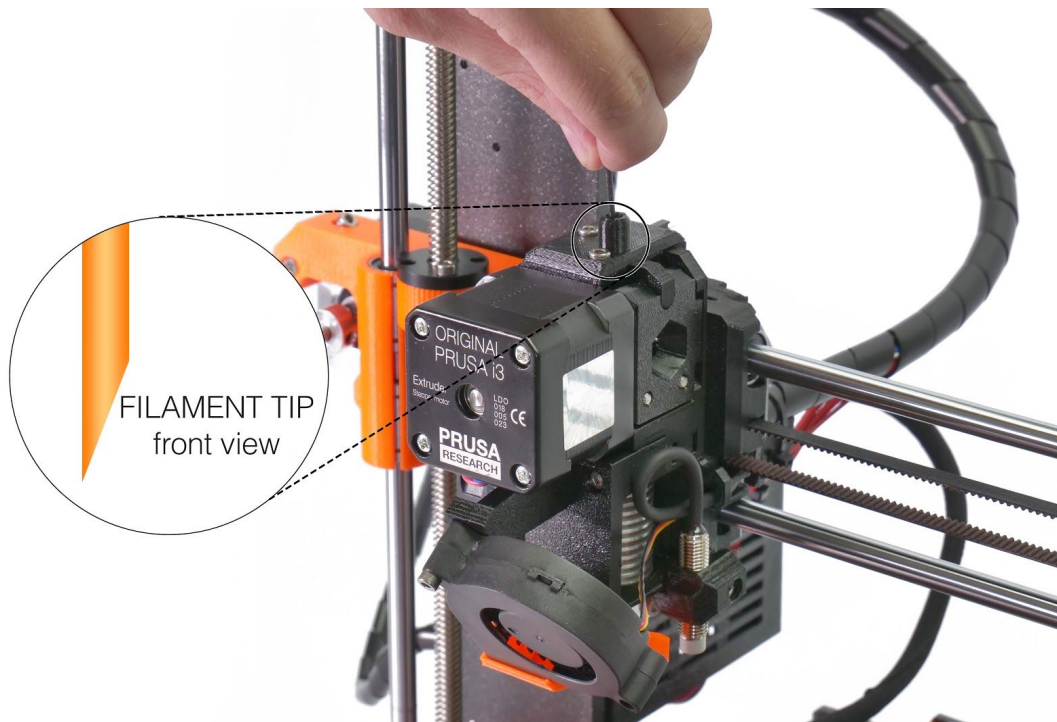

Pict. 9 - Loading the filament into the extruder



Always check if the filament is flowing from the nozzle! If you change the filament for a different one, do not forget to completely remove the old filament before printing by extruding the filament from **LCD Menu - Settings - Move axis - Extruder** until the color is completely changed.

If your filament is running out during a print, you can easily change it for a new spool. Just go to the LCD menu, select **Tune** submenu and press **Change filament**. The printer will pause, the print head will go out of the print area, unload the old filament, and the LCD will guide you on what to do. You can even insert filament of a different color and make your prints more colorful. Check out chapter [10.6 Printing in color with ColorPrint](#) to find out how to make more intricate color models.



Read chapter about our new [12.3 Filament sensor](#) and its functions.

6.3.8.1 Unloading the filament

This procedure is similar to the loading operation. **Preheat** the nozzle for material you used last time (pre-assembled printers are shipped with PLA). Wait for the temperatures to stabilize and use the **Unload filament** option from the menu.

6.3.9 First layer calibration (kit only)

Now we will finally calibrate the distance between the tip of the nozzle and the probe.



Check if your print surface is clean! You can find instructions on how to clean it in the chapter [6.3.2 Flexible steel sheet surface preparation](#). Don't forget to complete [6.3.5 Calibrate XYZ](#) chapter or **you can permanently damage the print surface!**

You can launch the calibration from **LCD Menu - Calibration - First layer cal.**

The printer will probe the bed and start printing a zig zag pattern on the print surface. The nozzle will be at the height based on the PINDA probe setting, it must not by any means touch the printing surface.

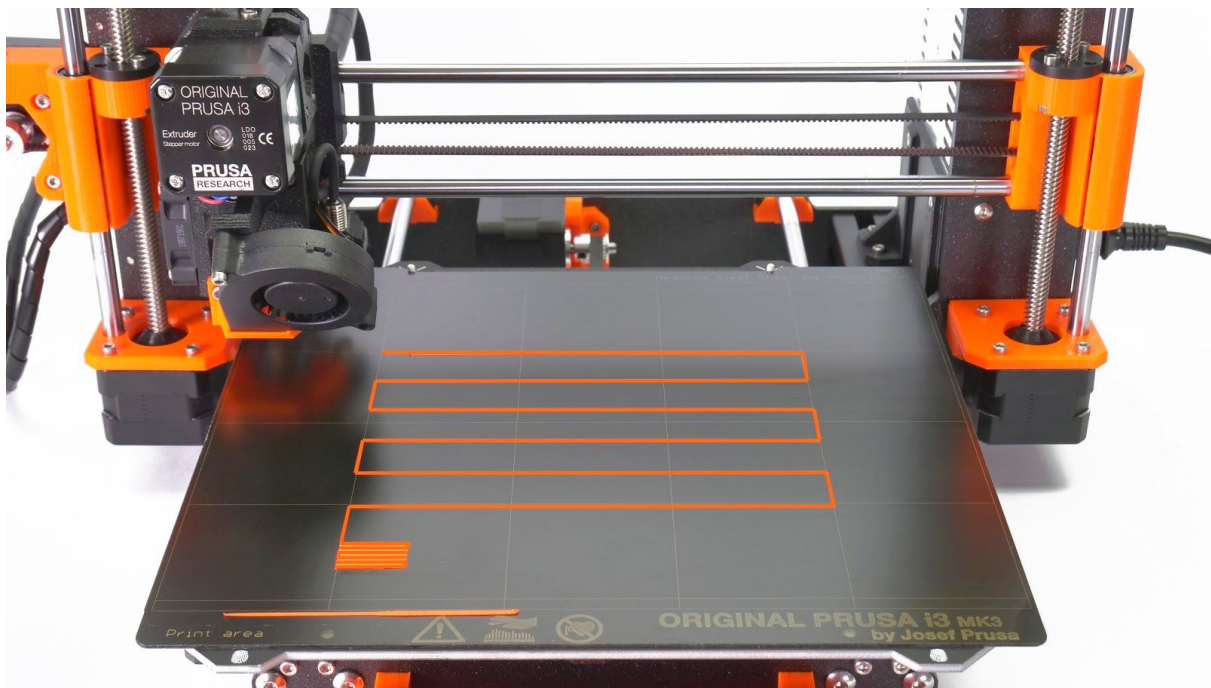

Adjusting Z:

-0.640 mm

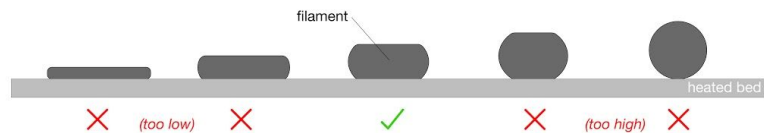

Pict. 10 - How to tune the nozzle height live during the test print. Note: -0.640 mm is only for illustration. Your setting will be different!

Observe the line which is being extruded on the print surface. A new menu will automatically show up where you can tune the nozzle height in real time by turning the knob. The aim is to adjust the nozzle height until the extruded plastic sticks nicely to the bed and you can see that it is being slightly squished. The value should not exceed -2.000 mm. **If you have to adjust it more (e.g. 2.500), move the P.I.N.D.A probe slightly higher. Please refer to our knowledge base in case the P.I.N.D.A probe needs to be re-aligned.**

Loosen the M3 screw on the probe holder to make adjustments. Gently push or pull the sensor to adjust the height and tighten the M3 screw again. Then re-run Calibrate Z followed by the First layer calibration again.

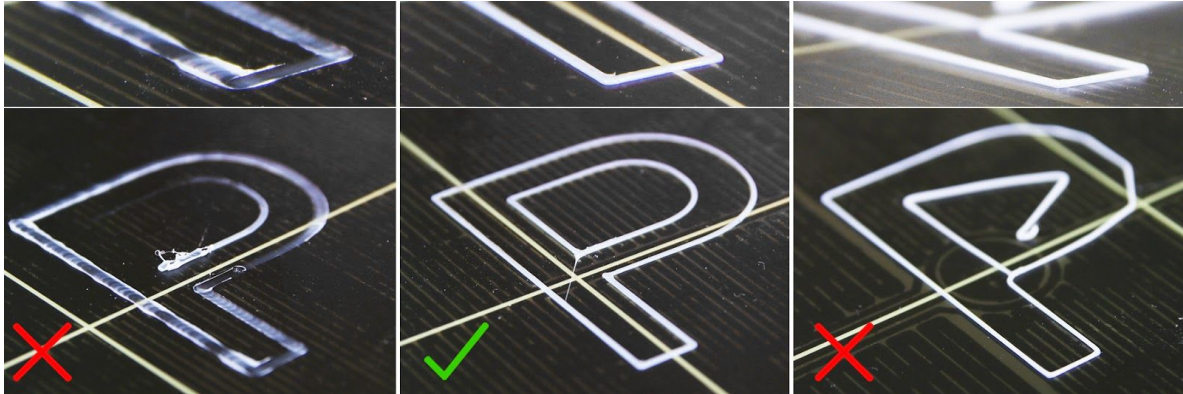

Pict. 11 - The properly-tuned first layer



When printing the extruder motor can reach up to 55°C, that is completely fine, they are designed to run up to 100 °C. It needs to work harder compared to the MK2 as the Bondtech gear is larger.

6.3.9.1 Bed level correction (kit only)

Bed level correction is an advanced feature that is designed to allow advanced users to correct for the slightest imperfections in the first layer. This feature can be found in **LCD Menu - Calibration - Bed level correction**. For example, if the first layer seems to be ever so slightly more squished on the right side, you can virtually raise the nozzle by **+20** microns on the right side. Settings are available for Left, Right, Front and Back. The limit is +-50 microns and even +-20 microns can make a huge difference. When you are using this function, do small incremental changes. A negative value will act as lowering the bed in the selected direction.

6.3.10 Fine tuning the first layer

6.3.10.1 Print Prusa logo

After finishing the calibration gcode, it is a good idea to print a simple object. The Prusa logo from the supplied SD card is a great example. The **Live adjust Z** function (described in [6.3.9. First layer calibration](#)) works during every print, so you can fine tune at any point. You can see the properly-tuned first layer in Pict. 12.



Calibration might be slightly different for different steel print sheets as the coating thickness varies. It is a good practice to check the first layer and adjust accordingly with **Live adjust Z** when switching between different types of steel sheets.

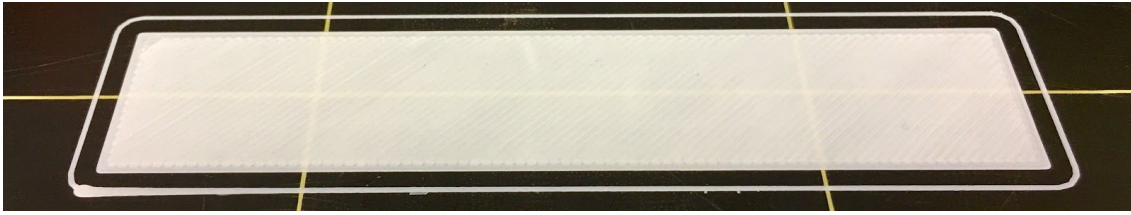

Pict. 12 - Perfect Prusa logo first layer

6.3.10.2 Check probe height (kit only)



If the first layer seems inconsistent between multiple prints, the probe might be too high. Lower it slightly. Loosen the M3 screw on the probe holder and gently push the sensor to adjust the height and tighten the M3 screw again.. Then try again **Calibrate XYZ**. Keep in mind, the probe must always be higher than the nozzle tip, otherwise it will catch on prints.

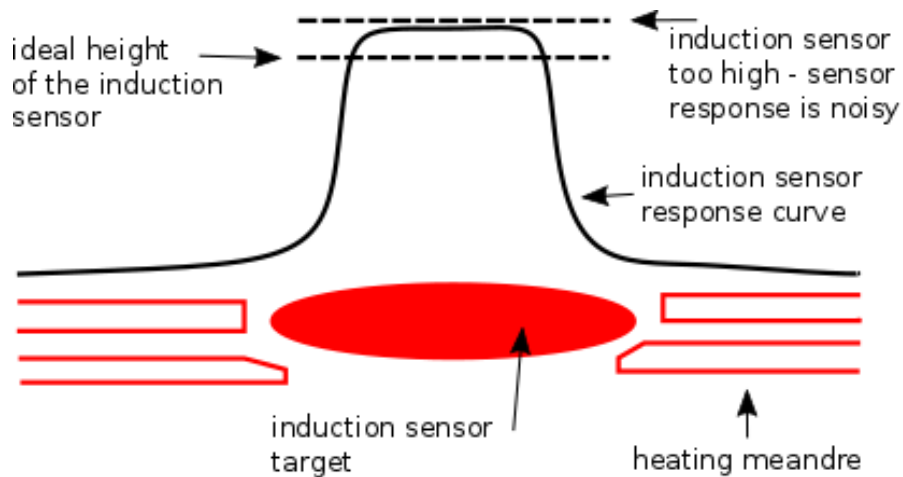

Pict. 13 - Probe response diagram.

Now you are done!

7 Printing

Make sure that the nozzle and the bed are heated to the desired temperature. If you forget to preheat the printing nozzle and the bed before printing, the printer will automatically check the temperatures of the nozzle and the bed; printing will start when the desired temperature is reached - that can take several minutes. However, we recommend preheating the printer beforehand as described in the chapter [6.3.8 Loading the filament into the extruder](#).



Do not let the preheated printer idle. When a printer is preheated and non-printing, material in an extruder degrades over time - it may cause the nozzle to jam up.

- **Watch the first few printed layers to be sure filament has attached to the bed properly (5 to 10 minutes).**
- Press the LCD-knob and choose the **Print from SD** option from the menu, press to confirm and pick the desired model **file_name.gcode**. The printer will start printing the object.



The **filename (.gcode) must not contain any special characters** otherwise the printer is not able to display the file on the LCD.

7.1 Removing objects from the printer

Removing prints from the build plate is much easier because of the ability to remove and bend the build plate. Different thermal expansion of the steel sheet and plastics used in 3D printing also helps with detaching prints after the plate has cooled down.

- When the printing is finished, let both nozzle and heatbed cool down before removing the printed object. Always handle the printed objects when the temperature of the bed and nozzle drop to room temperature. When the bed is hot, objects are very hard to remove. Remove the steel sheet from the printer and bend it slightly; prints should pop off.
- If you experience any troubles removing the object (especially the small ones), you can use a flat tool like a spatula **with rounded corners** to prevent damage to the PEI. Slide the spatula under the corner of the object and gently push until the print pops off.



Pict. 14 - Removing the model from the PEI print surface by bending the steel sheet.



If the prints still do not want to get loose or you need to bend the sheet too much (which you should not do), try to bend the sheet **inwards**.

7.2 Printer Control

There are two ways to control the printer. You can use the LCD panel integrated with the printer, or you can connect your computer via the USB cable. We suggest the **LCD panel** because of its speed and reliability, and moreover you do not have to rely on a computer.

7.2.1 LCD screen

The main screen is an **information screen** displaying the most important details. They are the temperature of the nozzle and the heatbed (1, 2), printing time (3) and the actual Z-axis position (5).



Pict. 15 - LCD layout

1. Nozzle temperature (actual / desired temperature)
2. Heatbed temperature (actual / desired temperature)
3. Progress of printing in % - shown only during the printing
4. Status bar (Prusa i3 MK3 ready / Heating / file_name.gcode, etc.)
5. Z-axis position
6. Printing speed
7. Remaining time estimation (since firmware 3.3.0)

7.2.2 Controlling the LCD screen

Controlling the LCD screen is done by a single control element: a rotational knob that you press to confirm selection.



Pict. 16 - LCD screen and control buttons

By single pressing the control button on the information screen, you enter the main menu.

The reset button is placed directly under the control knob. Pressing the reset button equates to quickly toggling the power switch. It is useful when the printer exhibits weird behavior or you see a failed print which requires immediate cancellation.

During some LCD functions like Calibration Wizard, you may encounter special symbols in the bottom right corner.

∨ ∨ Double down arrow informs you that the message contains more screens which automatically switch and you should wait.

⏏ Tick sign informs you that you need to press the control knob to continue.

 **Shortcut:** Quick access to Move Z axis function - press and hold the Control knob for 3 seconds

7.2.3 Print statistics

The printer tracks printing statistics. When you access this option during a print, you will see statistics for the running print. If you do so while the printer is idle, you will see the lifetime statistics. Both filament usage and print time are tracked.

```
Total filament :  
                    5.94 m  
Total print time :  
    0d : 1h : 58 m
```

Pict. 17 - Print statistics

7.2.4 Fail stats

The printer keeps statistics about the failures it experienced and recovered from during the last print. It is useful for assessing a long print, for example over a night or a weekend, if everything ran smoothly. Fail stats are placed at the bottom of the LCD menu.

Failures which are detected:

- Filament runout
- Power panic
- Lost steps / shifted layers

7.2.5 Normal vs. Stealth mode

The printer offers two print modes. **Normal mode** is required for the detection of lost steps (shifted layers) while still being quieter than silent mode on MK2/S. The second is called **Stealth mode** and utilizes Trinamic StealthChop technology, making the printer almost inaudible with the print cooling fan being the noisiest part of the printer. However, the **Stealth mode** does not provide lost step detection. Furthermore, printing in **Stealth mode** is about **20% slower** (depends on the particular model) than printing in the Normal mode.

These modes can be changed in two ways:

1. In **LCD Menu - Settings - [Normal/ Stealth]**
2. During prints **LCD Menu - Tune - [Normal/ Stealth]**

7.2.6 Factory reset

The factory reset is used when troubleshooting the printer and resetting it to the factory state.

Entering the factory reset menu:

1. **Press and release the reset button** (marked X and positioned under the control knob on the LCD panel)
2. **Press and hold the control knob** until you hear a beep
3. **Release the control knob**

Options:

- **Language** option resets the language preference.
- **Statistics** will erase all the recorded print time and material from the memory.
- **Shipping prep** which resets only the printer language selection. All the calibration data including the Live adjust Z remain intact. Even though the calibration data are still present and functional, the printer will prompt the user once to run the Calibrate Z function. This “light” factory reset is mainly used for resetting of assembled printers before shipping out of the factory so that users can select their language and run Calibrate Z after unpacking.
- **All data** which resets everything including all calibration data and the whole EEPROM is cleaned. After this reset, the user is expected to go through the calibration flow again, except setting the probe height.

If you experience random glitches after a firmware update, or after a printer upgrade, use the **All data** option.

7.2.7 SD card sorting

The list of the files on the SD card can be sorted; you can change the sorting type in **LCD - Settings - Sort: [Type]** you can select to sort by **name**, by **date** or **no sorting**. The best is by time where the newest files will be shown on top.

Folders are shown on the top of the SD card menu and then other files follow.

7.2.9 LCD layout

Items not mentioned below are not used for the common print setup - you should not change any of the unmentioned items unless you are absolutely sure what you are doing.

- Info screen
- Live adjust Z (during the printing process only)
- Tune (during the printing process only)
 - Speed
 - Nozzle
 - Bed
 - Fan speed
 - Flow
 - Change filament
 - Mode
- Pause print (during the printing process only)
- Stop print (during the printing process only)
- Preheat
 - PLA - 215/60
 - PET - 230/85
 - ABS - 255/100
 - HIPS - 220/100
 - PP - 254/100
 - FLEX - 230/50
 - Cooldown
- Print from SD
- AutoLoad filament (Load filament if filament sensor is turned off)
- Unload filament
- Settings
 - Temperature
 - Nozzle
 - Bed
 - Fan speed
 - Move axis
 - Move X
 - Move Y
 - Move Z
 - Extruder
 - Disable steppers
 - Filament sensor - On / Off
 - F. autoload - On / Off
 - Fans check - On / Off
 - Mode - Normal / Stealth
 - Crash detection - On / Off
 - Lin. correction
 - Temperature calibration - On / Off

- RPi port - On / Off
- Live adjust Z
- Select language
- SD card - Normal / FlashAir
- Sort - Time / Alphabet / None
- Sound
- Calibration
 - Wizard
 - First layer calibration
 - Auto home
 - Selftest
 - Calibrate XYZ
 - Calibrate Z
 - Mesh Bed Leveling
 - Bed level correction
 - PID Calibration
 - Show pinda state
 - Reset XYZ calibration
 - Temperature Calibration
- Statistics
- Fail stats
- Support
 - Firmware version
 - XYZ calibration detail
 - Extruder info
 - Belt status
 - Temperatures
 - Voltages

7.2.10 Print speed versus print quality

Printing a small object takes a few minutes, but printing larger models is more time consuming - there are prints taking up to tens of hours. The overall printing time can be changed using various methods. The first way how to affect the printing speed is to change layer height in Slic3r - the upper right window shows Print settings option. The default setting is 0.15 mm (OPTIMAL), but you can speed up the printer by choosing the 0.20 mm (FAST) option. Raising the speed will result in the model being less detailed with visible layer borders. If you prefer quality over speed, choose 0.10 mm (DETAIL) option. Printing time will double, but the model gets the extra detail. Again, a higher printing speed results in a less-detailed model.



Pict. 20 - Print quality vs print time

The speed can also be changed while printing. The LCD shows the FR 100 % item - it's actual print speed (feed rate). By turning the LCD-knob clockwise you can increase the print speed up to 999 %. However, we do not advise increasing the speed over 200 %. Watch the results of increased speed on the printed model and adjust the speed accordingly.

i When increasing the speed always check that the model is cooled properly - especially when printing a small object from ABS, increased speed causes distortion (sometimes called “warping”) of the model. You can prevent this issue by printing more similar objects together - layer printing interval is long enough to prevent this issue.

If the model shows a lower quality than desired, you can decrease the printing speed - turn the LCD-knob counterclockwise. Minimum usable printing speed is around 20 % of the nominal speed.

7.2.11 USB cable and Pronterface

i We strongly recommend using the LCD panel / SD card while printing on the Prusa i3 MK3 - Pronterface doesn't support all functions of the new firmware (e.g. filament change while printing).

Keep in mind that when printing from Pronterface, the **computer must be connected to the printer during the whole printing process** - the computer must be prevented from sleep, hibernation, or shutting down. Disconnecting the computer during the print ends the printing without the option to finish the object.

- Connect the printer to the computer with the USB cable.

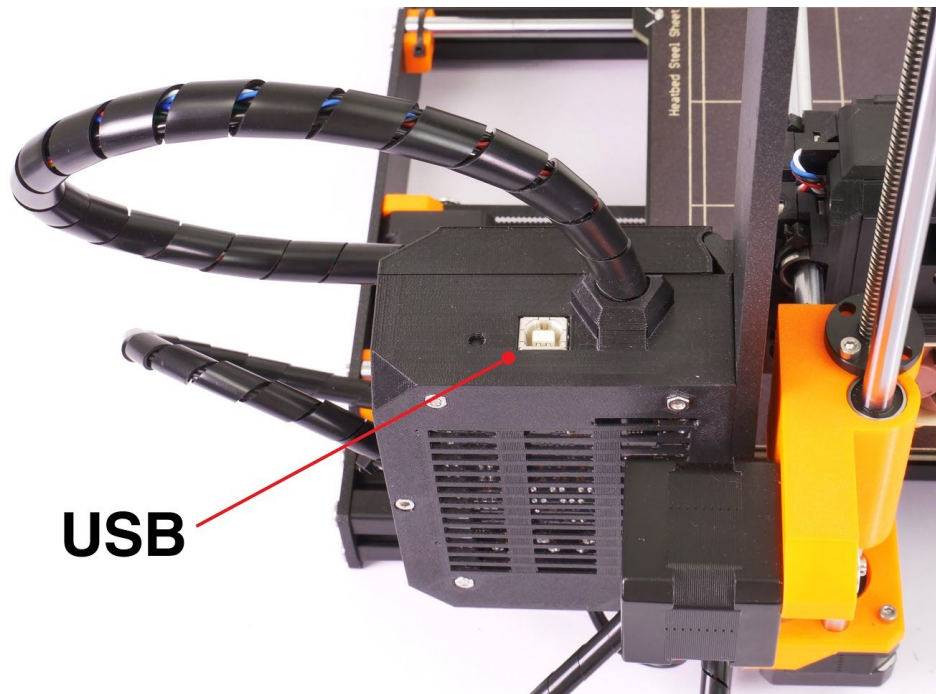

Pict. 21 - You can find USB port here

- Choose the connection port in Pronterface (download available with the printer drivers; see the chapter [9 Printer drivers](#)): Mac users use `/usbmodem` port, PC Windows ports are COM1, COM2, etc.; the correct port is displayed in the device manager, Linux users connect the printer using the virtual serial port. When the printer is connected, click the **Connect** button. The right column displays the connection information.
- The next step is loading the model with **Load model** button and choosing the **file_name.gcode** (no special symbols in file name).
- You can control the movement of all printer axes using the control area.
- Next you can preheat the printer and prepare it for printing. Set the temperatures for the nozzle (heater) and heatbed (bed) and click **Set** button. The printer starts heating up immediately. **Always check that the temperatures set in Pronterface are correct according to our material guide!**
- You can check the actual temperatures of the nozzle and the bed in Pronterface.
- When the model is loaded, the right column shows the estimated print duration: **Estimated duration (pessimistic)**

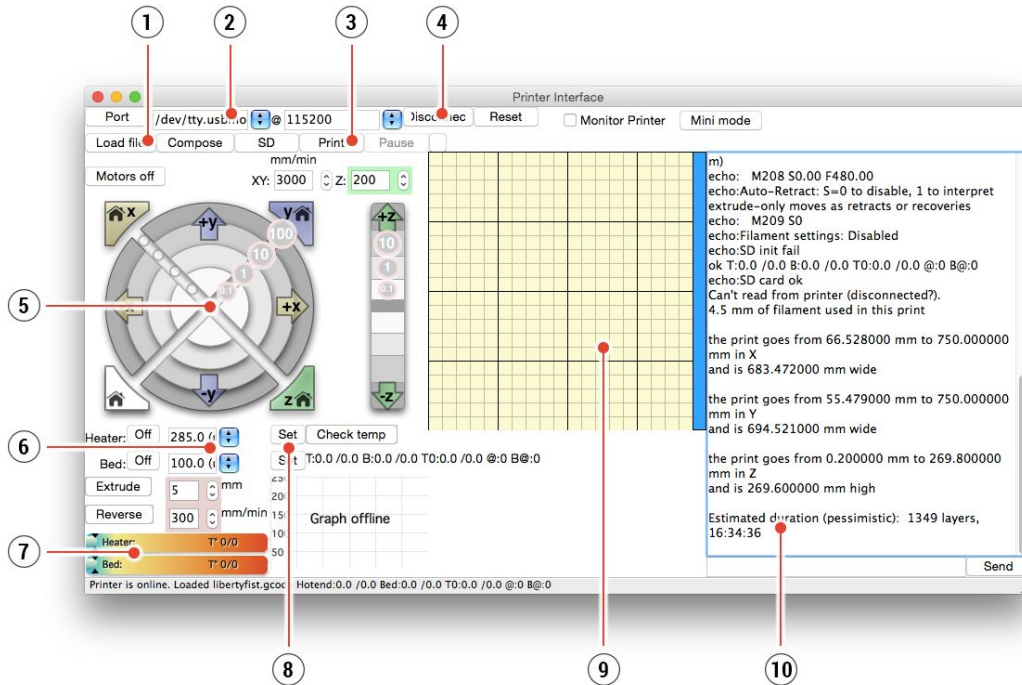

Pict. 22 - Pronterface

1. **Load file** button is used to load the desired model. The model must be in a ***.gcode** file format.
2. Choose the port by which the printer is connected to the computer (mostly */usbmodem* for Mac, COM1, COM2, etc for Windows PC).
3. The **Print** button starts the printing process.
4. The **Disconnect** button disconnects the printer from the computer.
5. Printer controls. Here you can manipulate the printer axes.
6. Setting the nozzle and bed temperatures.
7. Thermometer.
8. Confirming the set temperatures, heating starts.
9. 2D print process preview.
10. Info panel. Estimated print time, axis position and other info are displayed after loading the model.

7.2.12 Power panic

The printer can fully recover from a complete loss of power without the need for batteries. A special sensor detects mains voltage and in case of an interruption, it immediately shuts down the heatbed and extruder heating, leaving enough power in the capacitors to store the position and lift the print head away from the print. In case of a very short power failure, the printer will attempt to continue printing immediately without waiting for user interaction. Starting with firmware 3.4.0, the printer can recover from consecutive power outages or even very short power outages (<50 ms).

When the power comes back, the printer will give you an option to continue the print. Keep in mind that during long periods without power, the bed will cool down and the print can detach

itself from the sheet plate. Power panic doesn't work if you interrupt the print with the on/off power switch.

7.2.13 Crash detection

The Trinamic drivers on the EINSY board can detect skipped steps and layer shifting. It works only in the **normal mode (not in the Stealth mode)**. The thresholds for crash detection are set for higher speeds because layer shifting happens most of the time when the extruder moves fast between objects and hits a piece of curled up print. Make sure that your **belt and pulley are tightened**. Would any of them be loosened, it may cause the belt jump over the pulley or the pulley to spin around the motor shaft and the printer will not be able to detect it. Check out the chapter [13.4 Loose X- and/or Y-axis belts](#).

If you want to test crash detection, just pinch the smooth rods and let the extruder hit your hand. Crash detection doesn't work if you push the extruder in the direction of its movement. That's not a real-world scenario and normally never happens during print.

7.2.14 Temperatures

By default, the printer shows the heatbed and hotend temperatures on the LCD screen. If you want also to check the ambient temperature and temperature measured inside P.I.N.D.A. probe, you can do so in the LCD Menu - Support –Temperature menu. The same menu is available during the print.

The printer uses the ambient temperature reading to differentiate between MINTEMP caused by low ambient temperature (below 16°C) and an actual problem with either the thermistor or the heating element. The thermistor embedded in the P.I.N.D.A. 2 probe tip is used to compensate for temperature drift to ensure perfect first layer no matter the material.

7.2.15 Voltages

If you witness really long preheat times or the printer is behaving in a weird way, you can check the PSU output voltage in the **LCD Menu - Support - Voltages** menu. You should see a value of around 24V (+- 0.5V). If you see a drastically different value, check the connection between the PSU and EINSY board and contact our support if the problem persists. In a future firmware release you'll also be able to check the heatbed voltage.

7.2.16 Safety timer

This feature turns off the nozzle and bed heaters if the printer is idle for more than 30 minutes.

7.2.17 Beeper settings

Starting firmware 3.4.0 there are 4 levels of the acoustic signalization: **Loud, Once, Silent and Mute**. The user is able to choose between each level in the printer's **LCD Menu ->**

Settings → Sound. You can also change the sound settings during the print in the **LCD Menu → Tune.**

Level description:

- **Loud** - printer uses acoustic signalization for a failure or if confirmation is needed
- **Once** - this level is similar to Loud, but all beeps are played only once.
- **Silent** - most of the beeps are muted, the user is informed only in case of a serious error
- **Mute** - printer stays muted regardless of the importance of the error

7.2.18 Language settings

Firmware 3.3.0 introduced the option to switch between different languages. Right now, the following languages are supported: English, Czech, German, Spanish, Italian, Polish.

Go to the printer's **LCD Menu - Settings - Language** and select any of the available languages. The list of languages will be further expanded by future firmware updates.

To flash firmware 3.3.0 (and newer versions), you need to use Slic3r PE's built-in firmware flasher. Please refer to chapter [12.9 Updating printer firmware](#).

7.3 Printer addons

7.3.1 Different nozzles



You have to use proper preset settings for different nozzles in Slic3r or PrusaControl.

Please, check out how to change the nozzle in section [12.6 Replacing / changing the nozzle](#).

7.3.1.1 Hardened steel nozzle by E3D

E3D, a UK-based company, that supplies hotends for the Original Prusa i3 MK3, has a whole ecosystem of upgrades and addons. We support some of them including the hardened steel nozzle.

Hardened steel nozzles are a must for **highly abrasive materials**. Regular brass nozzles will degrade very quickly and lose their properties.

Most of the abrasive materials are composites, plastics with additives. Some examples are ColorFabb XT CF20, ColorFabb Bronzefill, ColorFabb Brassfill and some glow-in-the-dark

filaments. Always ask your filament vendor if you are not sure. A slight disadvantage is that some standard materials like ABS are not able to be printed as fast as with a regular nozzle.

7.3.1.2 The Olsson Ruby nozzle

Similarly to hardened steel nozzle, the Olsson Ruby is designed to print highly abrasive materials. However, since most of it is made from brass, it retains the excellent heat conductivity and throughput of the stock brass nozzle. Even though the ruby gemstone is highly wear resistant, it's also brittle. If you have your Live Z adjust set incorrectly (extremely low - big negative number) or if you misalign your P.I.N.D.A. probe and the nozzle hits the removable steel sheet, it may crack. Do not overtighten the nozzle (1 Nm max).

7.3.1.3 0.25 nozzle by E3D

E3D, a UK-based company, that supplies hotends for the Original Prusa i3 MK3, has a whole ecosystem of upgrades and addons. We support some of them including the 0.25 nozzle.

To get finer detail on 0.1mm or 0.05mm print settings, you can use a 0.25mm nozzle. But use it for only very small objects, e.g. a few centimeters in size. The print time can be considerably longer compared to 0.4mm. The ideal use is for jewelry.

7.3.2 Original Prusa Multi Material Upgrade 2.0

Multi Material Upgrade 2.0 is the second generation of our unique addon, which enables your 3D printer to utilize up to 5 colors at the same time.

Now compatible with the Original Prusa i3 MK2.5 and MK3 3D printers, MMU 2.0 went through a major revision, resulting in a simpler and more reliable design. The number of simultaneously supported filaments increased to the total of five, which enables the users to print even more complex and more colorful objects.

MMU 2.0 comes with a redesigned body and a new filament loading mechanism. Instead of the previous Bowden system, the new unit uses a direct-drive feed and a single PTFE tube to lead the selected filament to the extruder. The motorized selector head has a F.I.N.D.A filament sensor and a built-in blade, which prevents filament jamming.

To unlock the full potential of the MMU 2.0, use our latest Slic3r PE slicing software, which comes with new features, such as Smart wipe tower, Wipe into infill or Wipe into object.

To learn more, visit the official website <https://www.prusa3d.com>

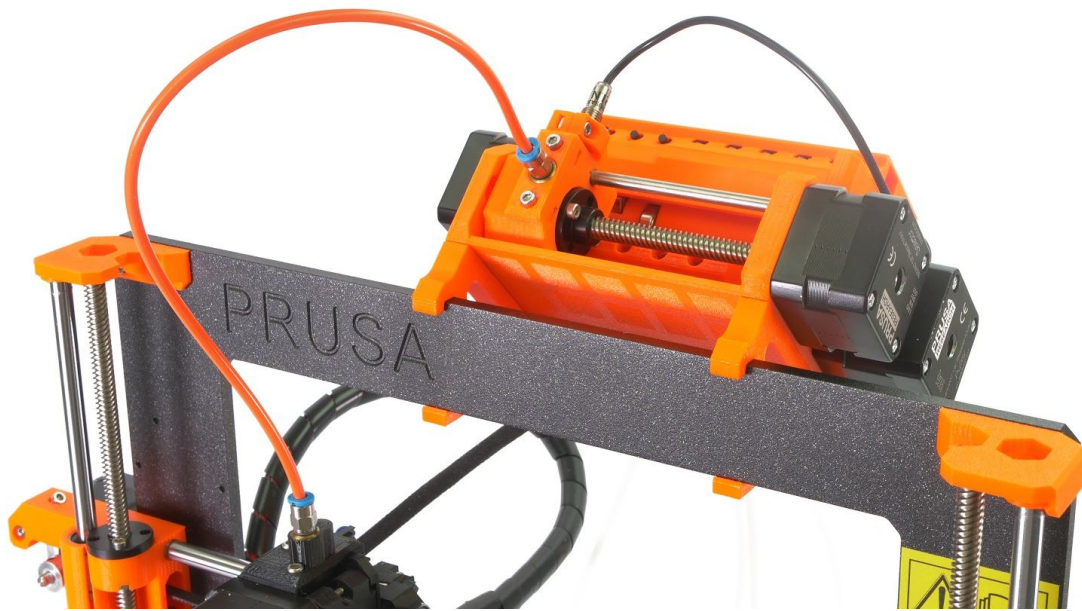

Pict. 23 - Multi Material Upgrade 2.0 mounted on the Original Prusa i3 MK3

7.3.3 Connecting Raspberry Pi Zero W

Raspberry Pi Zero W can be connected to the accessory header of the printer motherboard (EINSY) which will provide power and a serial data line for communication. After the connection, you can run applications like OctoPrint (octoprint.org) or Repetier Server (www.repetier-server.com/) to control the printer via a web browser interface.



PowerPanic functionality will not work with OctoPrint as of now, but Prusa Research is working with OctoPrint developers on implementing it.

You can always find up-to-date, **detailed instructions for connecting Raspberry Pi Zero W** at manual.prusa3d.com under the MK3 manual section. This walkthrough includes information about purchasing necessary components, printer disassembly, assembly, and configuration.

There is also an article at help.prusa3d.com which helps you with the **configuration of Octoprint and advanced settings**. You can find it in the Printing section.

8 Advanced Calibration

Additional calibration tools and settings for advanced users are available, but they are entirely optional and some of them are even experimental.

8.1 PID tuning for Hotend (Optional)

If you are experiencing wide swings in temperatures of your nozzle (e.g +/- 5 C°), you shall do PID tuning on your printer. *If you are experiencing major temperature fluctuations higher than that, first check that your hotend thermistor is properly seated in the heater block and plugged into your EINSY board.*

You can find this feature in **LCD Menu - Calibration - PID calibration**. In this menu, you have the option to choose the temperature for which the PID will be run. Set the temperature with which you print the most as it will tune itself ideally for the selected temperature. However, the general stability will improve for all temperatures (PLA/ABS/PETG). After that, the nozzle will heat up to the set temperature in 5 cycles. During the cycles it is mastering the amount of power needed to reach the temperature and maintain it.



Do not touch the nozzle during this process until the process is fully finished as it will reach high temperatures!

Be aware that PID tuning is not a solution to all of the temperature fluctuation issues. Always make sure that your printer is located in a room with stable ambient temperatures; more information can be found at **Thermal Runaway and Temperature Drops** at help.prusa3d.com.

8.2 P.I.N.D.A. probe calibration / Temp. calibration (Experimental/Optional)

All induction proximity probes drift the sensing distance with increased temperature. This might affect the quality of the first printed layer. P.I.N.D.A. v2 probe, included in the MK3, has an embedded thermistor inside its body to measure the temperature and fully compensate for the drift. A pre-calibrated data table is stored in the printer and the temperature calibration is active by default.

You can re-calibrate the data table from the menu; it can be found in **LCD Menu - Calibration - Temp. calibration - Calibrate**. Before you do so, please make sure that your nozzle and heatbed are perfectly clean as the extruder will be moving around the heatbed during this process.

This procedure must be done in a place with normal room temperature around 21°C/69°F.

Do not touch the nozzle or heatbed during this process until the process is fully finished as it will reach high temperatures!

Once calibrated, your P.I.N.D.A. probe will be comparing its data readings under different temperatures and also, additionally, it will include your Live Z data. This should help you to have a stable Live Z.

Nevertheless, make sure that your 1st layer is done properly. More about that in [6.3.10. Fine-tuning the first layer](#)

8.3 View XYZ calibration details (Optional)

This feature can be found in **LCD Menu - Support - XYZ cal. Details** and provides access to more detailed info about XYZ calibrating results. The 1st screen tells you the distance of the “perfect” position of your two front calibration points. Ideally, all of these are positive and at least 10 mm or more. **When you get your axes perpendicular or slightly skewed, nothing needs to be tweaked because the printer will perform with the best accuracy.**

```
Y distance from min:
Left:  11.89 mm
Right: 11.82 mm
```

Pict. 24 - Distance of the front calibration point from the axis start.

Pressing the button will get you to the 2nd screen. This screen will identify how far you are from the perfect perpendicularity. It is measuring the skew of your X/Y axis.

*Up to 0.25° = **Severe skew compensating** for offset of 1.1 mm on 250 mm length*

*Up to 0.12° = **Slight skew compensating** for offset of 0.5 mm on 250 mm length*

*Under 0.12° = **No need to compensate**, X/Y axes are perpendicular. Congratulations!*

8.4 Linear Advance (Experimental)

Linear advance is a new technology which predicts the pressure build-up in the extruder when printing at higher speeds. Firmware of the printer uses that prediction to decrease the amount of filament extruded just before stopping and decelerating, which prevents blobs or artifacts at the sharp corners.



If you are using different slicers from Slic3r PE or PrusaControl, or you just want to tweak and play around with different values, you can manually change the settings in gcode script. **However, if you do not understand the concept of gcodes yet, or never played with editing it, stop reading here and skip to another chapter.**

The K values (the parameter affecting how much Linear Advance affects the print) measured and tested are as follows:

- PLA: **M900 K30**

- ABS: **M900 K30**
- PET: **M900 K45**
- Multi material printer: **M900 K200** for all materials

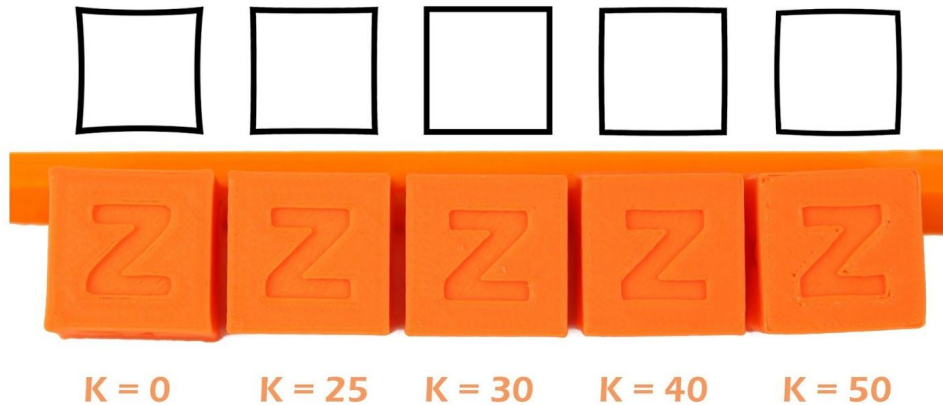

Pict. 25 - How K value affects the print

These values are preset in our Slic3r PE. The K value is set in custom gcode section in the **Filament Settings tab**, **NOT** under the printer specific custom gcode. **PrusaControl** uses the same K values but will not allow users to edit.

Simplify3D, Cura, ... users just need to add "M900 K??" into the starting gcode script. Keep in mind you need to manually change that for different filament materials. Only Slic3r PE has custom gcode for each filament preset and, therefore, K value is changed automatically.

Set the speed you want and print something (something large enough for speed to show up). If sharp corners have blobs, **increase the K value**. If you see filament missing, **decrease the K value**.



Please note that different brands and colors of the same material may require a slightly different K value when printing at extreme speeds, however, our presets should be fine with all of them.

8.5 Extruder info

Extruder info provides debug information about the extruder sensors. It provides info of:

- **Extruder cooling fan RPM**
- **Print cooling fan RPM**
- **Information of filament moving in the extruder**
- **Illumination level of the filament sensor** - optimally below 100

This information can be used to check the function of the fans and assess how well particular filament works with the sensor.

9 Printer drivers

Latest drivers and information can be found at www.prusa3d.com/drivers.

The driver package contains the following settings and programs:

PrusaControl - converting the 3D models to .gcode format for printing.

Slic3r Prusa Edition - converting the 3D models to .gcode format for printing.

Pronterface - legacy printing from a computer (in case you don't want to print from the SD card)

NetFabb - repairing corrupted or unprintable models

Settings - optimizing print settings for Slic3r, Cura, Simplify3D and KISSlicer

Drivers for Prusa i3 printer - Windows and Mac drivers

Test objects

10 Printing your own models

10.1 Where can you get the 3D models?

The best way to get started with your own 3D printing is to find already-created models on the internet - they should be in the **.stl** or **.obj** format . Fortunately, there are a lot of fans and there are sites from which you can download a large variety of ready-made 3D models - ranging from a simple shaver holder to a detailed aircraft engine model.

3D models are generally free to download under the **Creative Commons - Attribution - Non Commercial** (Models not to be used commercially, you must always include the name of the author) or for a small fee. We have selected the most interesting sites with high-quality models:

1. <http://www.thingiverse.com/>
2. <https://pinshape.com/>
3. <https://www.youmagine.com/>
4. <http://www.shapeways.com/>
5. <http://www.123dapp.com/>

10.2 In what program can you create your own models?

To create a 3D model yourself, you need a dedicated program. The easiest way to quickly create a model is TinkerCad (www.tinkercad.com) - an online editor (no installation needed) - where you create your 3D model directly in the browser window. It is free, easy to operate and you will find even basic video tutorials, so after a few minutes, nothing prevents you from creating your first 3D object.

Another popular tool for creating models is Fusion 360 (<https://www.autodesk.com/products/fusion-360/>) for PC, Mac and iPad. The website provides a quick guide along with detailed video tutorials so it is an ideal choice for novice enthusiasts

There is a great deal of 3D programs - free or paid - your choice depends more on your personal taste and preferences. The following is a list of other programs used for making 3D models: OpenScad, DesignSpark Mechanical, Blender, Maya, 3DS Max, Autocad and many more...

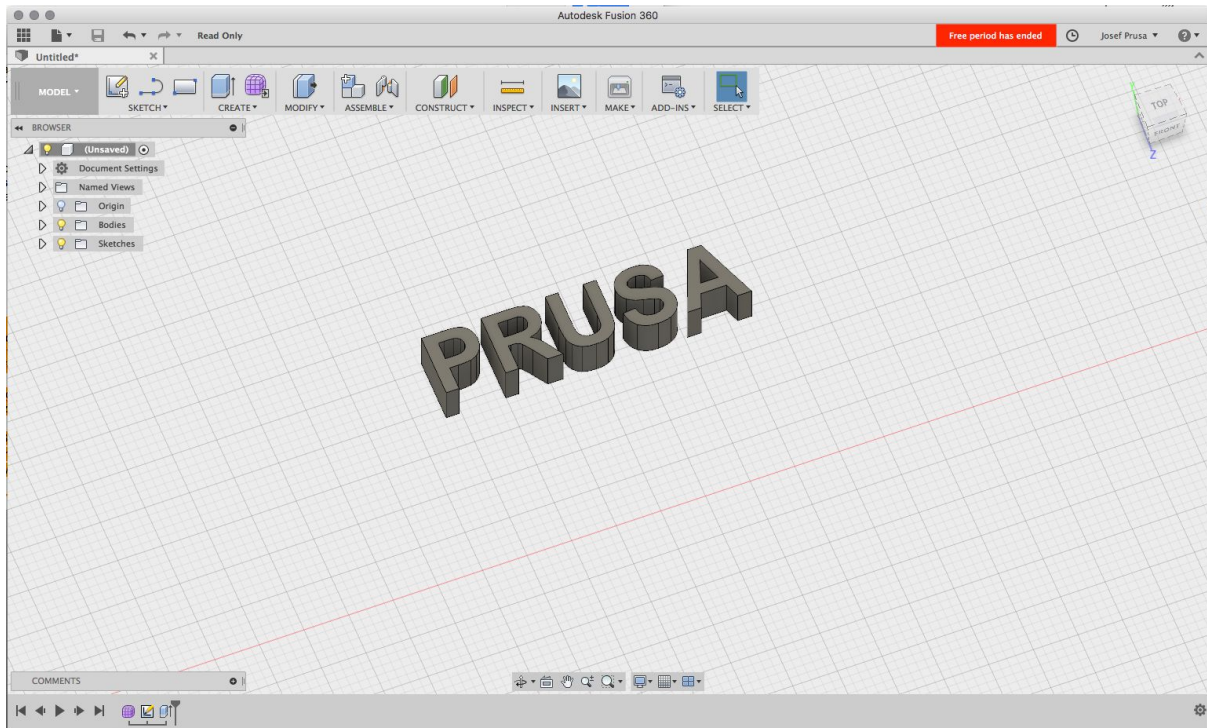

Pict. 26 - Fusion 360

10.3 PrusaControl

3D printers can print almost anything. Whether you've downloaded 3D models from the Internet or created your own models, you will need to **convert the .obj or .stl format into a .gcode file**. Gcode is a file format readable by 3D printers. The file contains information for nozzle movement and the amount of filament to extrude. We recommend using Slic3r PE, but if it's too complicated for you, give PrusaControl a try!

You specify the printing material, print quality and the print speed in PrusaControl. You can manipulate the object there, vary the placement on the printbed, resize it, etc.

PrusaControl is the easiest way to get perfect prints on the MK3 and should be used when first experiencing the 3D printing world. Once you get more advanced, and want to tweak the print settings, or add new materials, **Slic3r Prusa Edition** is waiting for you.

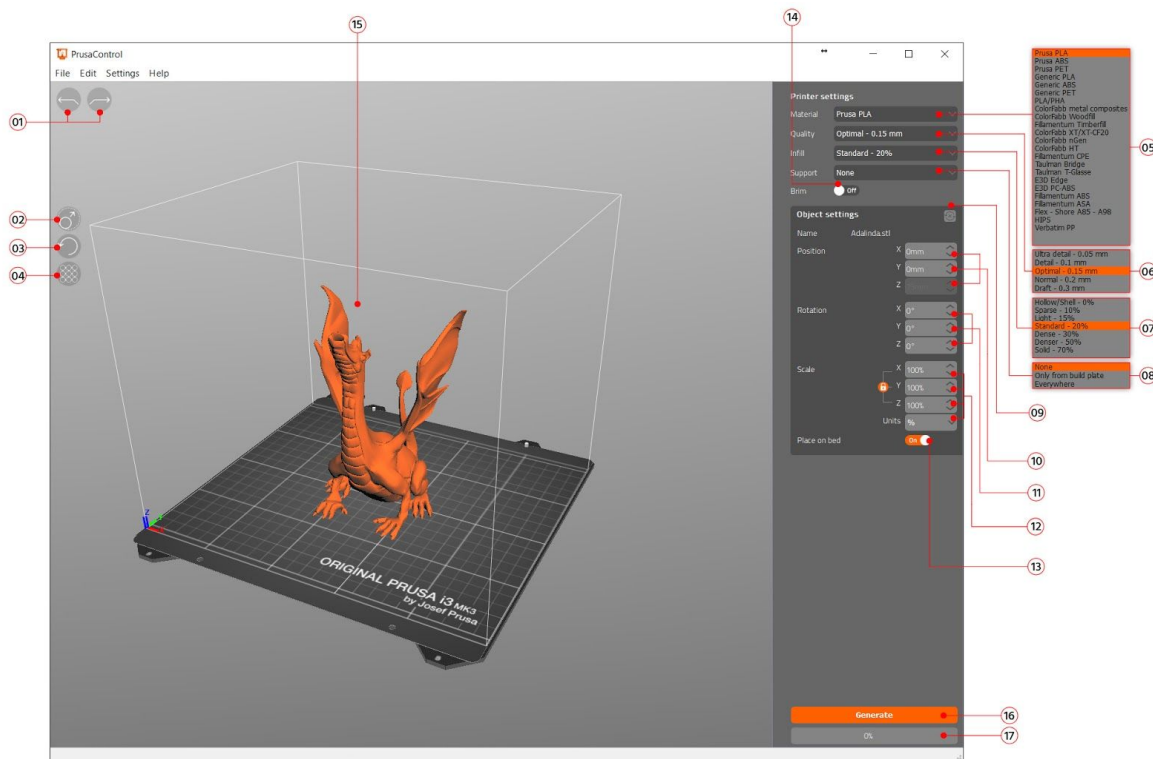

Pict. 27 - Prusa Control interface

1. **Undo/Redo** buttons return changes.
2. **Scale** button allows you to scale with the mouse while the model is selected.
3. **Rotate** button allows you to rotate with the mouse while the model is selected (outer circle step are 0,1°, inner circle step is 45°.)
4. **Auto arrange** button positions objects on the print bed.
5. Material selection menu
6. Quality / Speed setting of a print menu
7. Infill menu
8. Supports menu
9. **Reset transformation** settings button
10. **Position** values
11. **Rotation** values
12. **Scale** values
13. **Place on bed** button turns on automatic placing of objects to Z=[0]
14. **Brim On/Off** button
15. Model preview
16. **Generate** button slices the model
17. **Progress** bar

10.4 Slic3r Prusa Edition

PrusaControl is built on top of the Slic3r Prusa Edition slicing software and offers a streamlined user interface. However, it doesn't allow you to tweak advanced values and

parameters. To fully unlock the potential of your 3D printer, we strongly recommend using Slic3r PE, which is also regularly updated.

New versions of Slic3r PE have differential print settings, print profiles auto-updater and many other useful features. Also, please note that you will need the latest Slic3r PE to flash new versions of firmware.

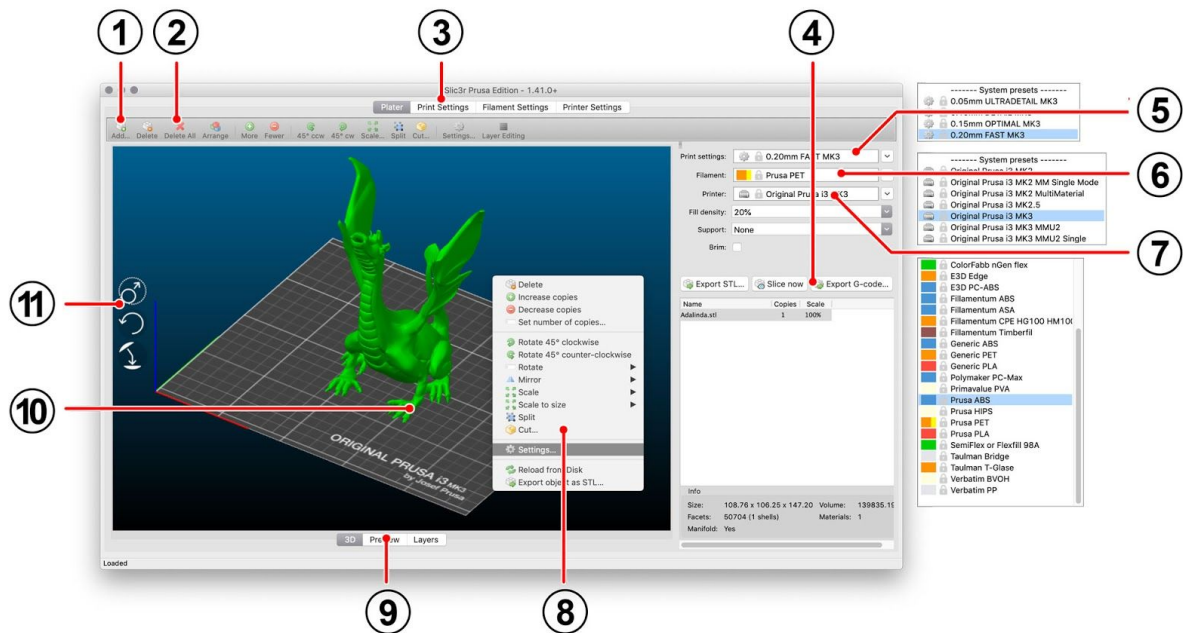

Pict. 28 - Slic3r interface

1. The **Add** button loads models into Slic3r.
2. **Delete** and **Delete All** buttons remove the model(s) from Slic3r.
3. Opens the detailed settings of print, filament and printer.
4. When the model is ready for print, this button generates the **.gcode** file.
5. Quality / Speed setting of a print
6. Material selection
7. Printer selection
8. Right-click on model opens the menu with rotate, resize and other options
9. Type of model preview
10. Model preview
11. Scale, rotate and Place on Face buttons

10.5 Bundled 3D models

We asked a couple of known 3D designers to prepare some printable objects for you to print. They are ideal for the first prints on your new printer. STL and GCODE files are available after installing the drivers package in the “3D Objects” folder, or bundled on your SD card. You can check them out at <http://www.prusa3d.com/printable-3d-models/>.



Pict. 29 - the 50-microns treefrog is commonly used as a 3D printing benchmark.

10.6 Print in color with ColorPrint

There is a simple way to create layer-based multi-colored 3D prints with PrusaControl or with our simple online ColorPrint app by manually changing the filament.



Pict. 30 - Multicolored object printed with ColorPrint

i ColorPrint is now directly integrated into the PrusaControl and filament changes can be added when the gcode is already generated before saving it to the file. PrusaControl can also add color changes to existing gcode (generated in Slic3r, for example). You can also use Web ColorPrint for gcode from other slicers including Slic3r Prusa Edition.

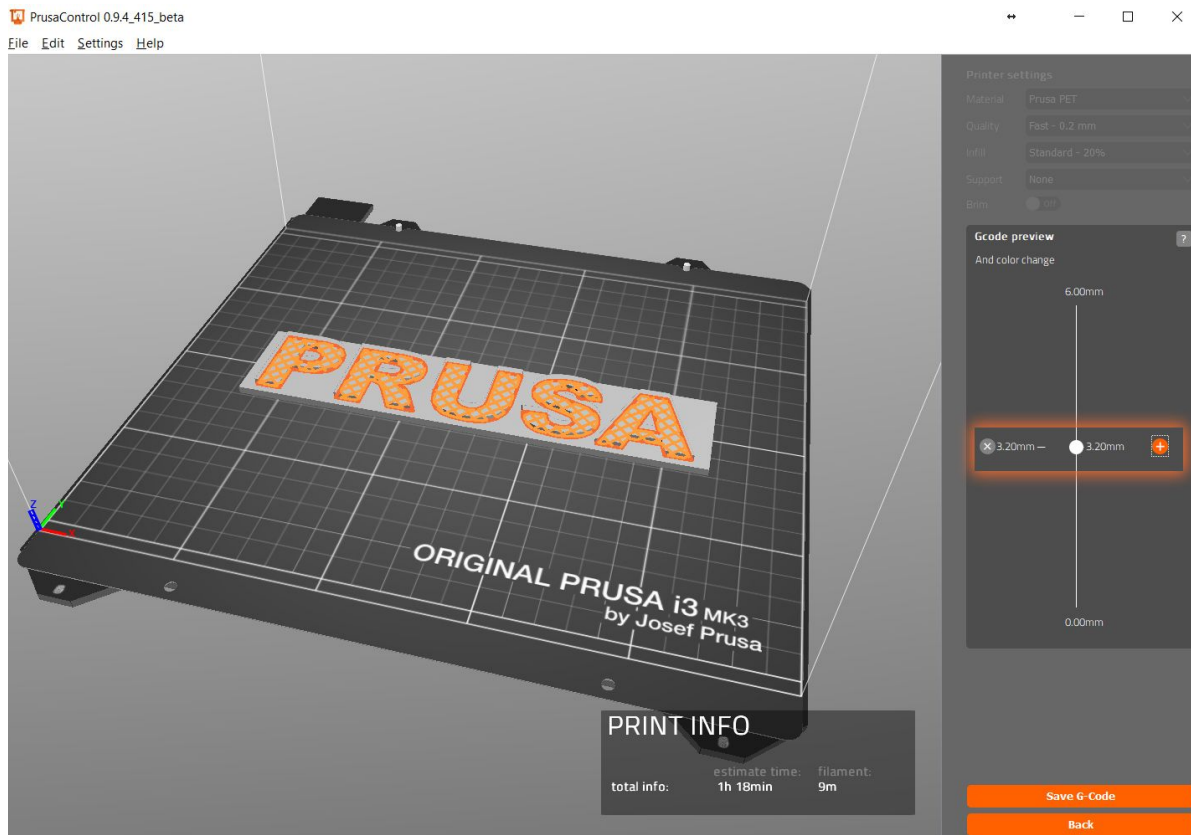

Pict. 31 - Adding color change in PrusaControl

- First of all, you need to prepare regular **gcode** with common print and filament settings. Save the file.
- Then go to **www.prusaprinters.org** and choose **Color Print** in the header menu.
- Drag the gcode to the frame and click on **Add change** button.
- Find the **height** of the layer where you want to make the color change. This can be easily found in Slic3r under tab "Layers." The scale along right side displays the height of individual layers. Set this number to the box. The number of these changes is unlimited.
- When you are done with your modification, download the file. This file is **ready** to be printed!

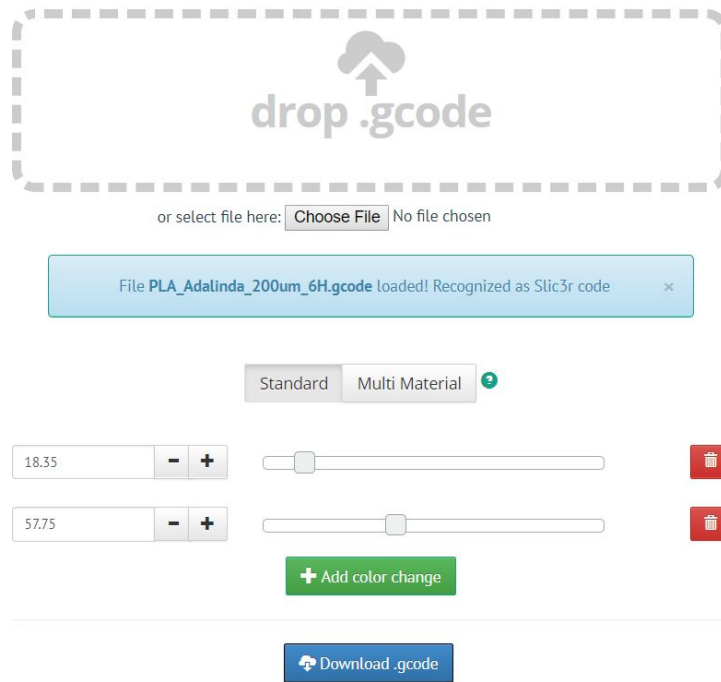

Pict. 32 - Web version of Colorprint interface at prusaprinters.org/colorprint

Insert the filament which you want to start with into your printer and start printing the file.

When the color change is triggered from the gcode, the printer will follow this simple procedure:

- Stop moving and retract
- Raise the Z by 2 mm and move quickly outside the printbed
- Unload the current filament
- You will get asked to insert the new filament. When you do so and continue, the filament will be pulled into the hotend and LCD will display **“Changed correctly?”** with three options:
 1. **“Yes”** Everything went ok and printing can continue. Check if the new color is clear without any remains of the previous filament - if so, choose this option to continue printing with a new color.
 2. **“Filament not loaded”** If the new filament was not loaded properly, choose this option and the printer will start the automatic filament load again. When the filament is loaded properly, you can choose the “Yes” option and the printing will continue with a new color.
 3. **“Color not clear”** Filament was loaded but the color is still mixed with the previous filament. Press the button with this option and the printer will extrude more filament from the nozzle. When the color is pure without any remains of the previous filament you can choose the “Yes” option and the printing will continue with a new color.

After confirming, the printer returns to the original position and continues to print.



Other option for **multicolored print** is to use the filament change option. Choose the **Tune** and then **Change filament** option during the print. The printer will pause the printing process, unload the filament and signal you to insert the new filament. The procedure is the same as above.



You should always use the same material or combine materials with similar print temperatures and settings.

10.7 Printing of non-standard models

Slic3r helps you while printing the non-standard models as models with overhangs and/or models larger than a printing bed.

10.7.1 Printing with support material

While printing models you can find special cases different from standard printing. The first case is printing with support material.

If you print an object with a gradient lower than 45° the material overhang would be preventing the object to be printed correctly. Slic3r allows you to print such objects thanks to the 'Printing with support' function. Support material is an extra structure printed as scaffolding for the object - you can remove the support material after the printing is finished.

Choose the *Print Settings* tab (1) and click the *Support Material* option (2) in the left column. First you have to check the *Generate support material* box (3). Next item - *Overhang threshold* (4) lets you set the minimal angle for printing the support material. Setting this item to zero lets the printer detect problematic parts automatically and print support where it is needed. *Enforce support* option (5) is used mostly with small models or models with a small base to prevent the object from breaking or tearing out from the bed.

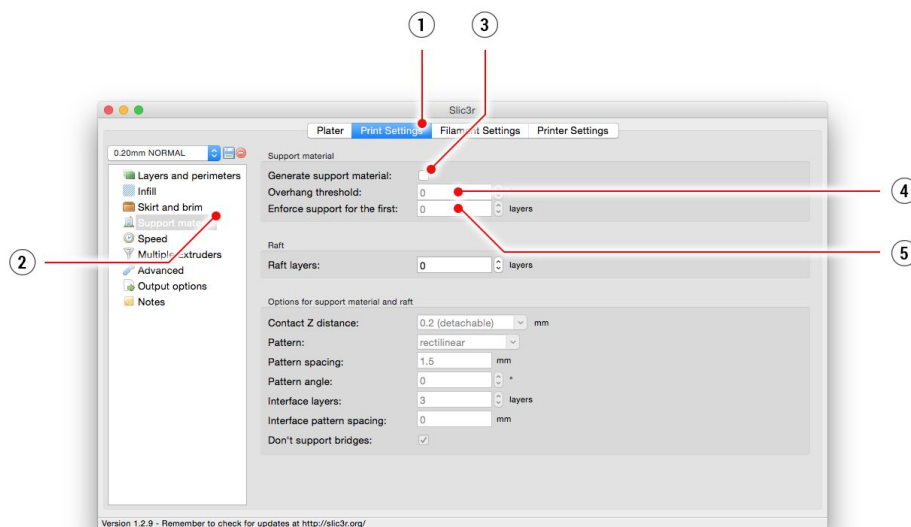

Pict. 33 - Print with support menu

10.7.2 Large object printing

Another special printing case is when printing objects larger than the heatbed. The first option is to resize the object to a printable size. Right-click on an object in Slic3r opens a menu with the *Scale...* option, then you choose *Uniformly*, if you want to scale down the model evenly; or you can alter the size of a model along the one of the axes: *Along X, Y, Z axis...*

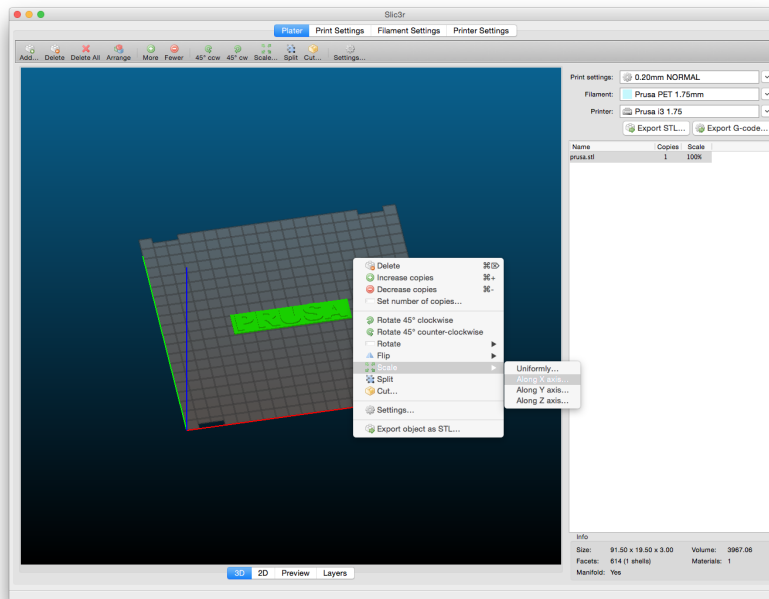

Pict. 34 - Size change of a printed object

If you need to print an object that does not fit the printer, you have to cut the object using Slic3r. Right-click and choose the *Cut...* option in the menu. You can cut the object horizontally - if you need to perform a cut in a different axis, use the *Flip...* option in the same menu.

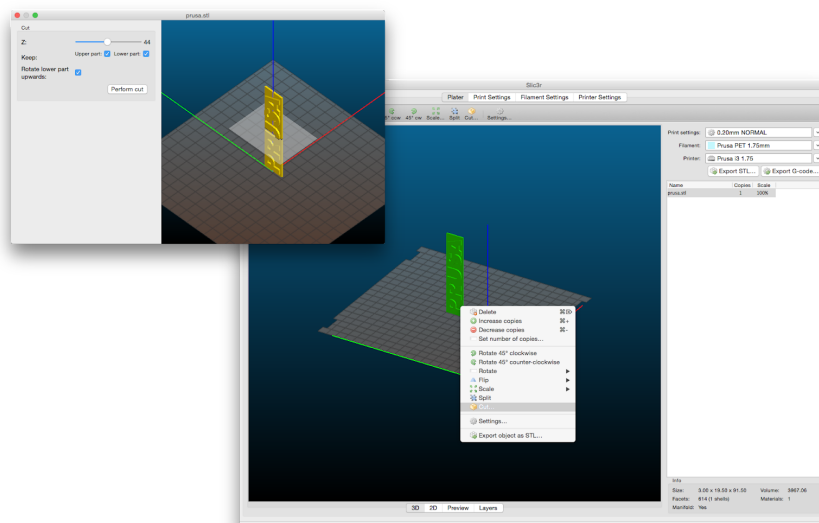

Pict. 35 - Cutting the object with the Cut option

11 Materials

Temperatures and the heatbed treatment before a print according to a specific material.

11.1 ABS

ABS is a very strong and versatile material with **great thermal resistance**. It's suitable for both indoor and outdoor use. ABS is a thermoplastic polymer; that means that just like PLA, it can be melted and crystallized multiple times without degrading too much. ABS, however, melts at a higher temperature than PLA. Higher melting temperature gives ABS great thermal resistance; your prints won't show signs of deformation **up to 98 °C**.

ABS includes high wear-resistance synthetic rubber, which makes it **very strong and impact resistant**. And last but not least, it's **soluble in acetone**! This makes it really easy to not only connect multiple parts together, but also allows you to **smooth prints** with acetone vapors. You still have to be careful when handling acetone, but it's not anywhere near as dangerous as PLA solvents, for example.



The best use of ABS is for architectural models, concept models, spare parts (car interior, gears, phone cases), etc.

On the other hand, thermal contraction is where ABS makes it really hard to successfully print something. And that's especially true when printing anything larger. Even with the heatbed at 100 °C, your part may start lifting from the build plate and warp. This, and the **unpleasant smell** of ABS, is why you should consider getting an enclosure for your printer when printing with ABS. Or at least place the printer in a warm room.

If you need to use your print outside, or just need your print to be stronger, give ABS a shot. After all, it's what **LEGO** is made of.

ADVANTAGES	DISADVANTAGES
High impact and heat resistance	Bad smell
Strong and versatile	Worse resolution
Soluble in acetone (easy post-processing)	Needs warm room or enclosure
Can be vapor smoothed	

- **Nozzle temperature:** 255 °C
- **Bed temperature:** 100 °C. You can set the bed temperature between 80 to 110 °C depending the size of an object (larger object means higher temperature)
- **Heatbed:** Make sure the surface is clean as described in [6.3.2 Flexible steel sheet surface preparation](#) chapter

11.2 PLA

PLA is the most commonly used filament. It's **biodegradable**, **easy to print**, and a very **strong** material. The perfect choice for printing **large** objects thanks to its low thermal expansion (little to no warping) and for printing **tiny** parts because of its low melting temperature. **Only this material is proven for 50 microns layer height.**

PLA has a relatively low melting temperature of about 175 degrees Celsius. Unlike so-called thermoset materials, PLA can be heated past its melting point multiple times with very little degradation. It's also very hard material, but that also means it's somewhat brittle, and once it breaks, it likes to shatter.



The best use of PLA is for printing concept models, prototypes, low-wear toys, etc.

However, PLA is not a perfect material and, just like every other plastic, has some disadvantages. The low melting temperature also means **low-temperature resistance**. Parts start to lose mechanical strength at temperatures over **60 °C**.

The combination of being both biodegradable and having low-temperature resistance means that it's **not ideal for outdoor use**, not to mention low UV-resistance. Also, PLA is only soluble in chemicals like chloroform or hot benzene. So when connecting multiple pieces, you're better off using just glue.

Even though PLA is biodegradable, and the material on its own is food safe, we do not suggest to repeatedly **drink or eat from your 3D prints**. Because of the small fractures on the print surface, bacteria can build up in there over time. You can prevent this by applying a food-safe coating. When **post-processing PLA**, it's better to use wet sanding. Without water you'll quickly start heating the plastic by friction, it will melt locally and make it hard to keep sanding.

ADVANTAGES	DISADVANTAGES
Easy to print	Brittle
Can print tiny parts	Low temperature resistance
Can print huge objects	Difficult post-processing
Hard and tough	
Low warping	

- **Nozzle temperature:** 215 °C
- **Bed temperature:** 50 - 60 °C
- **Heatbed:** Make sure the surface is clean, as described in [6.3.2 Flexible steel sheet surface preparation](#) chapter

11.3 PET/PETG

PETG is a very tough material with good thermal resistance. Its use is universal but especially suitable for mechanical parts and both indoor and outdoor use. PETG has almost **no warping**, so printing large objects isn't a problem. We use PETG to print parts for our printers!

PETG is one of our favorite materials for 3D printing. It's almost as easy to print as PLA, but it can offer many mechanical properties that PLA prints just cannot achieve.

The G in the acronym PETG stands for Glycol which is added during the manufacturing process. Glycol modifies the properties of PET, so that it's **easier to print, less brittle and clearer** when printing with semi-transparent variants. PETG has low thermal expansion, so even when printing big objects, and without an enclosure, it rarely lifts from the bed and warps. In addition to that, PETG is **ductile**. It has a healthy amount of flex which can prevent parts from breaking under pressure.

Unlike PLA or ABS, PETG tends to ooze a bit and may leave **strings of plastic** on your print. You can fight this with increasing retraction and playing with hotend temperature, but if you use our filament presets in **Slic3r or Prusa Control**, we already did that for you and the amount of stringing is minimal. If you witness a tiny bit of stringing anyway, you can get rid of it by quickly blasting your finished prints with a heat gun.

If you can handle the oozing and strong adhesion, you'll be left with a very durable print, that is considerably temperature resistant and usable for both indoor and outdoor use.

ADVANTAGES	DISADVANTAGES
Easy to print	Possibility of stringing
Good layer adhesion	Not soluble in acetone
Very tough, low warping	Prone to scratches
Temperature resistance	
Little shrinking	
Durable	

- **Nozzle temperature:** 240 °C
- **Bed temperature:** 80 - 100 °C
- **Heatbed:** Make sure the surface is clean, as described in [6.3.2 Flexible steel sheet surface preparation](#) chapter. Do not use isopropyl alcohol to clean the bed, or the adhesion may be too strong, if you do not have anything else on hand, use the bundled glue as a separator after cleaning it. Windex or similar windows cleaner is a great option for PET and you don't need to use the glue after the cleaning. Pour a little amount on an unscented paper towel and wipe the print surface.

11.4 HIPS

HIPS is high impact polystyrene, and as for behavior, it's similar to ABS, so it's easy to print. It's a universal and stable material with excellent heat resistance, and it produces very smooth layers. HIPS is also very malleable, and it can be dissolved using limonene. HIPS is mostly suited for printable mechanical components.

ADVANTAGES	DISADVANTAGES
Smooth	High level of warping
Durable	Bad smell
Soluble	

- **Nozzle temperature:** 220 °C
- **Bed temperature:** 100 °C. You can set the bed temperature between 80 to 110 °C depending the size of an object (larger object means higher temperature)
- **Heatbed:** Make sure the surface is clean, as described in [6.3.2 Flexible steel sheet surface preparation](#) chapter

11.5 PP

Polypropylene is a flexible and resistant material suitable for printing precise objects requiring the flexibility, firmness and persistence.

ADVANTAGES	DISADVANTAGES
Tough	High level of warping
Semi-flexible	
Temperature resistance	

- **Nozzle temperature:** 254 °C
- **Bed temperature:** 95 - 100 °C.
- **Heatbed:** The best results are obtained with common scotch tape - just attach the tape directly to the print surface and clean it after the print is finished.

11.6 Nylon (Taulman Bridge)

Nylon is a very tough material suitable for mechanical parts.

ADVANTAGES	DISADVANTAGES
Durable	Demanding storage (it's hygroscopic)
Chemically resistant	
Flexible, but strong	
Chemical resistance	

- **Nozzle temperature:** 240 °C
- **Bed temperature:** 80 - 90 °C.
- **Heatbed:** Use one coat of glue stick. Clean as described after the print.

11.7 Flex

Flex is a very strong and flexible material. There are many use cases where hard plastic is not the ideal or even unusable. But whether you need a phone cover, an action camera case or wheels for your RC car, flexible is the way to go.



Before you start printing from Flex, clean the nozzle from the previous material - preheat the nozzle and load PLA to remove any other previous material. When loading Flex, loosen the extruder (idler) screws. Keep in mind that when printing from Flex, the automatic filament change function may not work properly.

Flex has a very good abrasion resistance, remains flexible in cold environments, and is resistant to many solvents. It doesn't shrink much when cooling down, so you can be fairly accurate with your measurements and perfect fit models.

ADVANTAGES	DISADVANTAGES
Flexible and elastic	Needs extra steps when loading filament
Little shrinking	Can be tricky to print
Good layer adhesion	Needs to be printed slowly

- **Nozzle temperature:** 230 °C
- **Bed temperature:** 50 °C. You can set the bed temperature up to 65 °C depending on the size of an object. (larger object means higher temperature)

- **Heatbed:** Make sure the surface is clean as described in [6.3.2 Flexible steel sheet surface preparation](#) chapter. Some very soft flex materials can bond to the bed too much and require use of glue on the bed as a separator to prevent PEI damage.

11.8 Composite materials

Composite materials (woodfill, copperfill, bronzefill, glow-in-the-dark, carbon or aramid composites and many others) consist of a main plastic base and a second material in the form of dust. These materials tend (except for wood composites) to be very abrasive, therefore, a hardened nozzle is strongly suggested for long-term printing. A larger nozzle is recommended while printing with wood composites (0.5 mm and up). Please use corresponding print settings in Slic3r or PrusaControl as print parameters can be very different depending on the plastic base.

The first step in polishing is sanding. It's a good idea to start with a coarse grit size (80) and slowly move up the grit table. After sanding, a big improvement in polish can be achieved with steel wool or a brass brush. If you're still not happy with the finish, you can try wet sanding with a very fine grit (1500).

ADVANTAGES	DISADVANTAGES
Easy to print	Needs hardened nozzle
No warping	
Great look after post-processing	

- **Nozzle temperature:** 190 - 210 °C
- **Bed temperature:** 50 - 70 °C (bigger object -> higher temp.)
- **Heatbed:** Make sure the surface is clean as described in [6.3.2 Flexible steel sheet surface preparation](#) chapter.

11.9 ASA

Acrylonitrile-styrene-acryl (ASA) is a material with properties similar to ABS. Its main benefit is an increased weather and UV resistance. Another advantage is overall dimensional stability. To achieve a cast-like surface, acetone smoothing can be used...

ADVANTAGES	DISADVANTAGES
Heat and UV resistant	Bad smell
Soluble in acetone (easy post-processing)	High level of warping
Can be vapor smoothed	

- **Nozzle temperature:** 270 - 280 °C
- **Bed temperature:** 100 - 110 °C (bigger object -> higher temp.)
- **Heatbed:** Make sure the surface of the heatbed is clean. Usage of brim is suggested (see Prusa Knowledgebase).

11.10 nGen

Developed by Eastman Chemical Company and colorFabb, nGen offers increased resistance to heat as well as dimensional stability. The material is low-odor and styrene-free.

ADVANTAGES	DISADVANTAGES
High gloss	Brittle
Good surface finish	A bit of warping
Good layer adhesion	

- **Nozzle temperature:** 240 °C
- **Bed temperature:** 80 - 100 °C (bigger object -> higher temp.)
- **Heatbed:** Make sure the surface is clean. Do not use isopropyl alcohol to clean the bed, otherwise the adhesion may be too strong, use window cleaner instead. If you do not have anything else on hand, use the bundled glue as a separator after cleaning it. Windex or similar window cleaner is a great option for nGen and you don't need to use the glue after the cleaning. Spray a small amount on an unscented paper towel, and wipe the print surface.

11.11 PC-ABS (E3D)

Polycarbonate ABS (PC-ABS) is an enhanced version of traditional ABS. It offers easier processing, higher strength, stiffness, and temperature resistance. PC-ABS is also suitable for structures with openings and its bridging capability is improved compared to ABS. Typical usage of PC-ABS is for durable plastic parts like television or computer casings.

ADVANTAGES	DISADVANTAGES
Lightweight	Warping
Good for mechanical parts	Low elasticity

- **Nozzle temperature:** 270 - 280 °C
- **Bed temperature:** 100 - 110 °C (bigger object -> higher temp.)
- **Heatbed:** Make sure the surface of the heatbed is clean.

11.12 Dialing in new materials

Even though each manufacturer produces slightly different material, they belong to a same group. For example, Prusa PLA and ColorFabb PLA will have a slightly different output when printed.

To achieve the best possible output, you should experiment with the **nozzle temperature**, **fan speed**, **print speed** and **flow**. All of these can be changed even during a print from the **Tweak** menu on the LCD panel.

The same idea also applies even for materials which are not listed here. Take the manufacturer-suggested settings, find the closest match in Slic3r material profiles, modify and save as new. **Continue by printing a few simple test pieces and continuously use the Tweak menu.** After each improvement, don't forget to modify the settings in Slic3r.

Reset the tweak values before every print.

Don't forget to share your settings on our forums or directly with us.

12 FAQ - Printer maintenance and print issues

12.1 Regular maintenance

12.1.1 Bearings

Every couple hundred hours, the smooth rods should be cleaned with a paper towel. Then apply a little bit of general purpose machine oil on the smooth rods and move the axis back and forth a couple of times. This cleans the dirt and increases longevity.

If you feel the axis is not running smoothly anymore, bearings can be taken out and greased on the inside (they need to be removed from axis because the plastic lip will prevent the grease from getting inside). Super-lube, or any other multi-purpose grease, will do.

12.1.2 Fans

Both fans should be checked and cleaned every couple hundred hours; dust or plastic build-up can decrease their efficiency or even damage them. Computer cleaner spray will get the dust away and tweezers can be used for little plastic strands.

Both extruder and part cooling fans measure current RPM (Revolutions Per Minute). Because of that, they can detect any problem that will cause the fan to slow down, like a piece of filament getting stuck in it. If you get a fan error, check that it can rotate freely; clear any debris that may be stuck in it.

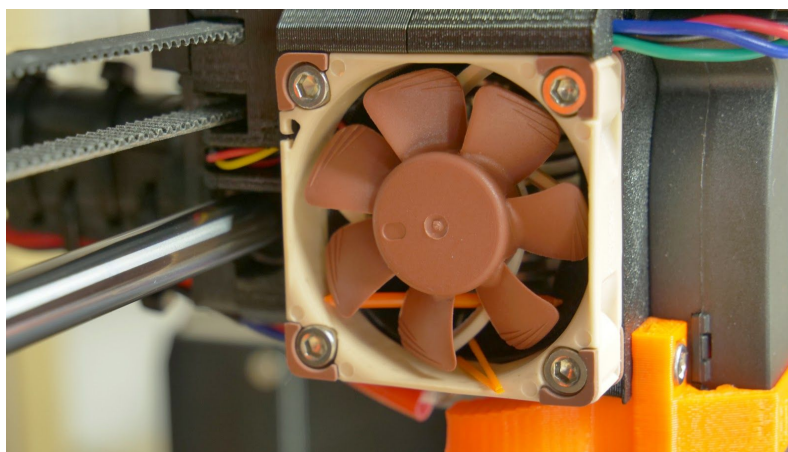

Pict. 36 - Nozzle cooling fan from Noctua

```
A 67/0°      Z 0
B 55/55°     *100%
SD---%      @--!--
Err: EXTR. FAN ERROR
```

Pict. 37 - Fan error

The nozzle cooling fan is made by **Noctua**. These premium fans are known for their superb quietness and exceptional performance.

You can turn off the monitoring in **LCD menu - Settings - Check fans** for example if you replaced one of the fans with a replacement not supporting RPM sensing.

12.1.3 Extruder drive gear

The Bondtech Extruder gears on the extruder motor shaft can have build-up of filament shavings in the grooves and cause under-extrusion. A small brass brush is an ideal tool to clean the grooves, but a regular toothpick will do the job as well. Check and clean from the access window on both sides of the extruder assembly. Clean what you can, then rotate the gear and repeat. Nothing needs to be disassembled. Clean when you see signs of missing plastic in the objects, e.g. missing lines of extrusion.

The Bondtech Extruder gears are made from hardened carbon steel. As the gear meshing section is constantly turning during operation it needs lubrication to reduce wear, lower the friction and to reduce noise. **A lithium based grease** is recommended to be used. **Oil is not recommended** since it might spread to the section where the filament is fed to the hotend. After extensive use it is recommended to remove, clean and inspect the gears. This is also a good time to also put some grease on the needle bearings in the secondary gear to keep the friction low.

12.1.4 Electronics

It is a good practice to check and eventually reconnect the electrical connectors on the EINSY RAMBo board. Do so after the first 50 hours of printing and then every 150-200 hours.

12.1.5 PEI rejuvenation

PEI can lose its adhesive powers after a couple hundred hours. Wipe it thoroughly with acetone when you see models getting loose to restore the adhesion.

12.2 Print surface preparation

Print surface preparation is described in [6.3.2 Flexible steel sheet surface preparation](#) chapter.

12.3 Filament sensor

The optical filament sensor detects the presence of filament and also its movement. Make sure you are running the latest firmware as we have increased the FPS of the sensor and improved its reliability. The filament sensor can detect:

- Running out of filament

- Filament getting stuck - jammed nozzle
- Filament quality / flow check - available in firmware 3.4.0 with the Filament sensor engine 2.0

Starting with printer firmware 3.4.0, the filament loading system is now based on the **Filament sensor engine 2.0**. Part of the software responsible for the analysis of the filament movement was rewritten to **increase the precision and reliability of the sensor**. With the new firmware, the filament runout should be always detected in time and the number of false detections drops significantly. Previously MK3 and MK2.5 shared similar values for the evaluation and it was sometimes causing issues on the MK2.5, this is now fixed.

Engine 2.0 brings also a **new feature for the filament evaluation**. During the filament load sequence, the filament is scanned using the IR sensor and evaluated. As soon as the filament is loaded to the extruder, the printer knows, whether **it can reliably control the filament flow** during the print or not. In case the sensor can't read the filament movement properly, the user is informed on the printer's screen, plus there's an option to turn off the sensor.

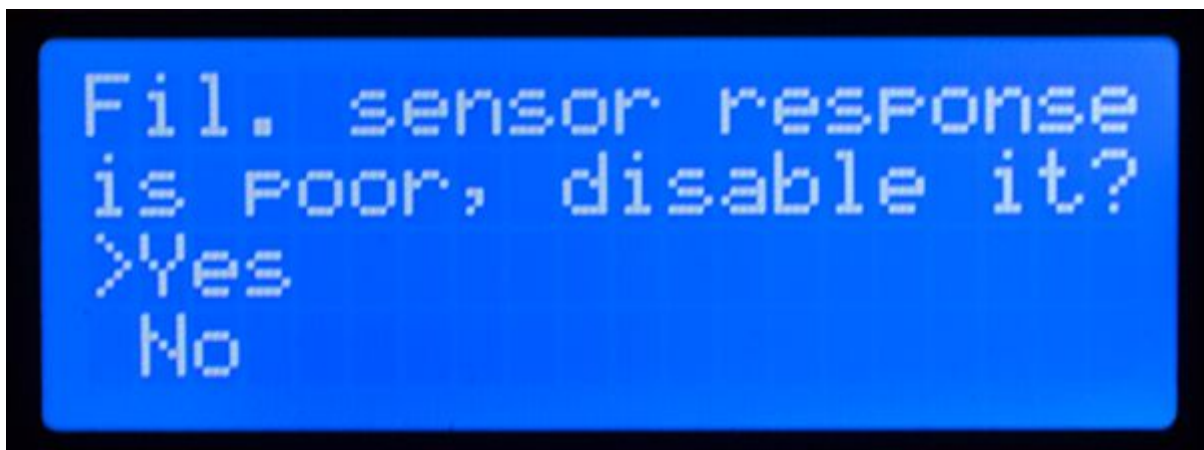

Pict. 38 - Information about filament quality (Filament sensor engine 2.0)

12.3.1 Running out of filament

Running out of filament **will no longer cause a print failure**. If you run out of filament, the printer will automatically pause the print, unload the remaining few centimeters in the heatbreak, and move the X-carriage away from the print. You will be prompted to replace the spool and insert a new filament. Use pliers to remove the extruded filament from the loading process. After that, you can continue in the **current print**.

12.3.2 Filament jam

The sensor can also detect a filament getting stuck. Unfortunately, in most cases, **it's not possible to recover the current print**, because it's hard to detect the exact moment of the jam happening. However, in a future version of the firmware, we plan to offer a few more options to possibly save the print. When the jam is detected, the printer will try to unload the

filament. However, this may not always be possible if too much filament was already ground off. Either way, the printer will stop, display a warning about the jam happening, and cool down to prevent any further damage.

12.3.3 False sensor readings and debugging

You can encounter false runout readings from the sensor. First check if the sensor is positioned correctly and connectors are properly seated.

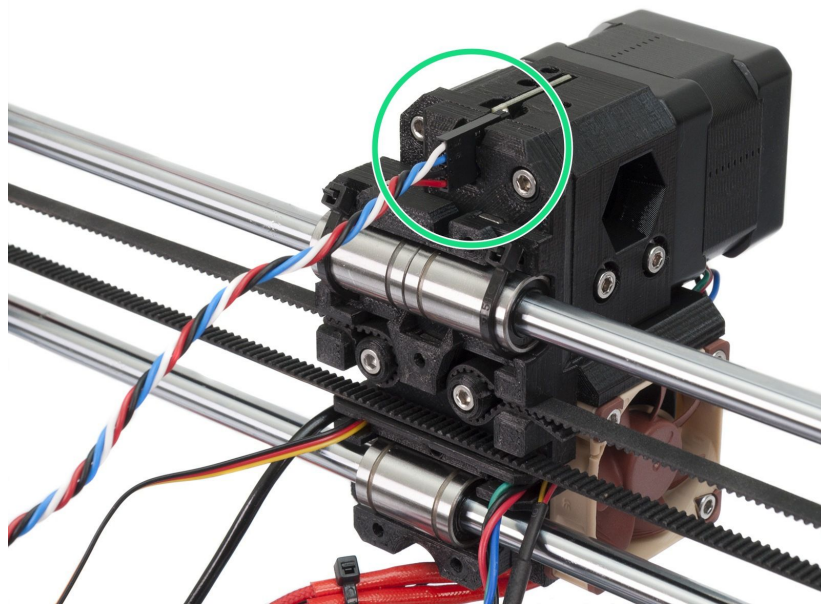

Pict. 39 - Properly connected filament sensor

If everything is in order, other causes might be:

12.3.3.1 Dust on the sensor - how to clean

If you start getting a lot of false alarms on filament jams or filament running out, your sensor might need cleaning. The easiest way is to use a compressed air. There is a dedicated hole in the x-carriage exactly for this purpose.

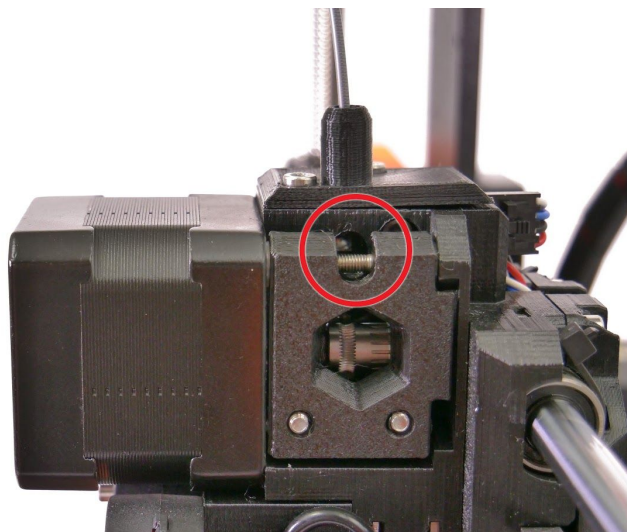

Pict. 40 - Access hole for cleaning the filament sensor

12.3.3.2 Extreme light conditions

If you're printing in **extreme light conditions** (e.g. direct sunlight, very strong LED lighting) you might also encounter some false alarms. Then consider turning the Filament sensor off for this specific print in **LCD Menu - Settings - Fil. sensor [on/off]**.

12.3.3.3 Exotic filaments

Some translucent filaments focus more light on the sensor and this can result in weird behavior. Certain colors like ivory, matte white or lime green can also cause false alarms. If you're printing with any of these filaments and you're getting a lot of false alarms, consider **turning the sensor off** in **LCD Menu - Settings - Fil. sensor [on/off]**.

12.4 Clogged / jammed extruder

Material clogged in the extruder can cause problems with the printing or with the loading of a new filament.

- Heat the nozzle, remove the filament from the extruder, and cut the rod about 10 cm above the damaged part.
- The next step is to clean the extruder. There is a service hole on the left side of the extruder where you can access the hobbed pulley (pict. 41).
- Clean the hobbed pulley, then heat the nozzle before reloading the filament.
- If a problem persists, you will have to clean the nozzle.

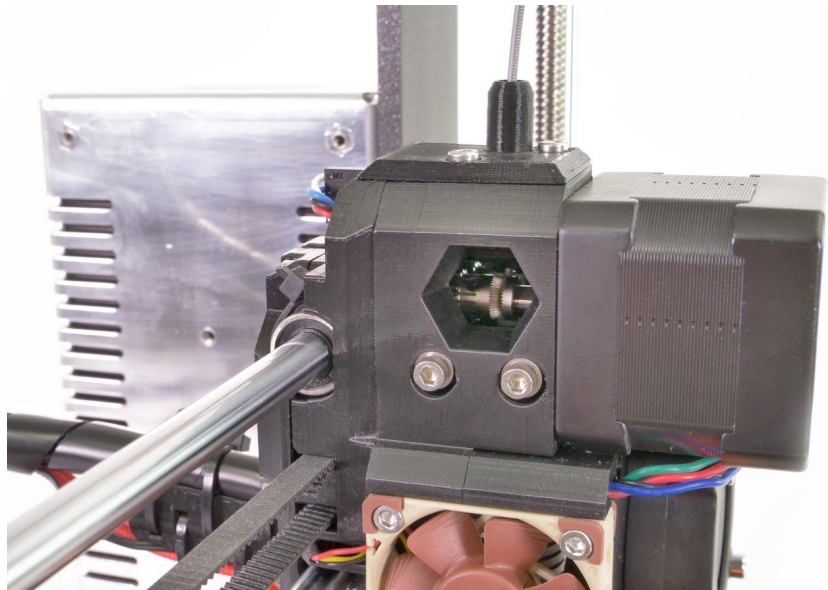

Pict. 41 - Cleaning the extruder - you can see the hobbed pulley through the service hole

12.5 Nozzle cleaning



Do not touch the nozzle during these procedures as it is preheated and you may burn yourself!



To make cleaning easier, move the extruder head up. On the **LCD menu - Settings - Move axis - Move Z axis**. As you will be operating with the hotend.

Use a wire brush to clean the nozzle from the outside. Heat the nozzle before you do so.

Filament is pouring out a little

If the filament doesn't go through the extruder smoothly and only a small volume is coming out, first check if the extruder fan is working properly and that the temperature is set correctly (**PLA 210 °C; ABS 255 °C, HIPS 220 °C, PET 240 °C**). Also check that the filament was correctly loaded into the extruder.

If that is not the case. Follow the instructions below:

1. Heat the nozzle according to the filament you want to print from. Load the filament and push a **bundled acupuncture needle** (0,3-0,35 mm) into the nozzle from below - between 1 and 2 cm deep.
2. Choose **Load filament** option from the LCD menu and check if filament is extruded properly.
3. Push the **acupuncture needle** into the nozzle again and repeat these steps a few times more. When the filament is extruded properly, the nozzle is clear.

None of the filament is going through the nozzle

If none of the filament is going through, then most likely, your hotend got clogged. In order to fully clear it, please follow these instructions:

1. Heat up the nozzle to 250 °C for PLA or 270°C for ABS jams.
2. Wait 3-5 minutes and then go to **LCD Menu - Load filament**. If you cleared the clog and the filament went through, simply lower the temperature to normal and re-do load filament again.
3. If the filament loads successfully, you can resume printing.

12.6 Replacing / changing the nozzle



If you are replacing the **Olsson Ruby nozzle**, please visit this website for instructions, otherwise you might damage it!

<http://support.3dverkstan.se/article/66-the-olsson-ruby-instructions-for-use> .



CAUTION: Heated parts can cause severe burns! Be extra careful around the hotend thermistor leads. You can break them off easily

- 1) Preheat the nozzle to 250-285°C (LCD Menu - Settings - Temperature - Nozzle).
Heating the nozzle is essential for this process!
- 2) Unload any loaded filament
- 3) Gain better access to the nozzle by moving the extruder axis as high as possible: Go to **LCD Menu - Settings - Move Axis - Move Z**. Alternatively you can just hold down the knob for a few seconds. Rotate the knob to set the height.
- 4) Unscrew the fan nozzle shroud (it's held by just one screw).
- 5) Hold the heater block with a 16mm spanner (or adjustable wrench) and unscrew it a little bit (about 45° is enough). This has to be done because you could potentially damage the thread on the other side of the heater block (the connection to the heat break)
- 6) Using the supplied pliers, or preferably a 7mm socket, unscrew the nozzle. Be careful, the nozzle is still hot!
- 7) Make sure that the set temperatures (250-285°C) didn't change. Carefully screw the new nozzle in and tighten it. Don't forget to use a spanner to hold the heater block.
- 8) Tighten the heater block back to its original position.
- 9) Reassemble the fan-nozzle shroud, insert a filament and you are ready to print.



Be careful, the nozzle is hot during this whole process and can cause burns!
Be careful around the hotend thermistor leads, you can break them easily.
Be careful, you can bend the heatbreak easily.

It is a good practice to run [6.3.9 First layer calibration](#) after changing the nozzle!

When the nozzle is fully screwed into the heater block, there is still a small gap between them. That's **normal**, do not try to overtighten the nozzle to get rid of the gap.

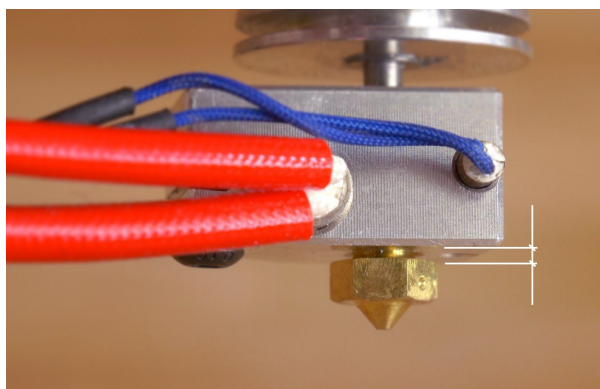

Pict. 42 - A gap between a fully screwed in a nozzle and the heater block

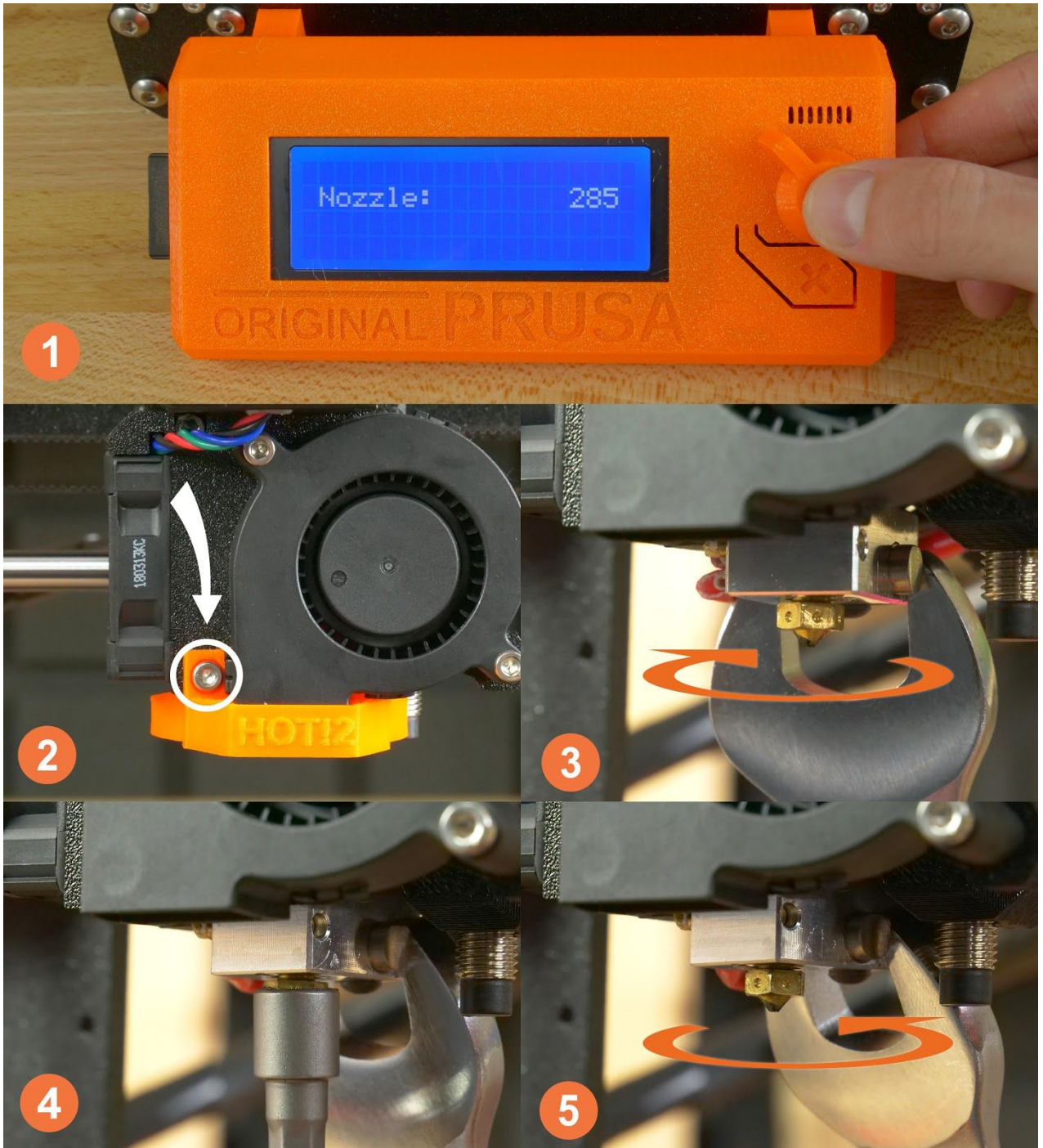

Pict. 43 - Nozzle change

12.7 Printing problems

12.7.1 Layers break and split when printing from ABS material

ABS material has a higher thermal expansion than other materials. We suggest other materials like PET, HIPS or PLA when you print larger models.

12.7.2 Models contain either too much or not enough of the filament

You can manage the filament flow during the print. Use the LCD-knob and choose **LCD Menu - Tune - Flow - xx%** where you can adjust the filament flow. Pronterface users can enter the value M221 Sxx into the command line.



When you change the filament flow, the next print will use the same settings unless you change it again in the menu, or reset the printer, or unplug it from the power source.

12.8 Problems with finished models

12.8.1 Model breaks and/or is easily damaged

This is a typical feature of larger models printed from ABS. If you have set the temperature properly, the printer is away from drafts and object design is right, the printed object should not break. The easiest way to avoid breaking, or overall model fragility, is to choose a different material. The strongest are PET, HIPS and PLA; while PLA has low heat resistance, PET is the firmest and has the lowest thermal expansion.



When parts break and there is no spare time to reprint the model you can use super glue or any other glue for plastics for temporary fix :).

12.9 Updating printer firmware

Flashing the printer's firmware brings various benefits. New firmware releases come with new features or bugfixes, so running the latest firmware is highly recommended. The flashing procedure is simple: it requires a USB 2.0 Type B cable, latest version of Slic3r PE (1.40.0+) and the correct firmware file.

Windows users should download the latest Drivers & Apps package from <http://www.prusa3d.com/drivers/> and install them. Make sure that "Drivers" and "Slic3r PE" are selected in the components list. MacOS and Linux users should download only Slic3r PE. At the same web address, find the correct firmware file for your printer. Keep in mind that firmware files are different for each model.

▼ ORIGINAL PRUSA I3 MK3

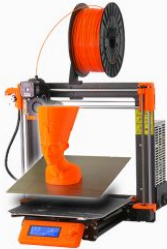

FIRMWARE 3.3.1 July 16, 2018

[Download 3.3.1](#)

CHANGES IN 3.3.1

- Filament statistics fix
- Fixed bug of G28 (auto home) gcode which used to cause undesired execution of mesh bed leveling after temperature calibration and occasional communication timeouts
- Load filament improvement (if current Z coordinate is lower than 20 mm when loading filament starts, the printer will increase Z-axis position to ensure, that there will always be enough space for cleaning the nozzle)
- Setup function fix

[See full release log](#)
[Older versions](#)

DRIVERS & APPS 2.2.0 August 30, 2018

[Download for Windows \(322MB\)](#)

CHANGES IN 2.2.0

- New sample objects for the MMU 2.0
- New Slic3r PE v1.41.0
 - Multi Material 2.0 upgrade support
 - Wipe into infill and/or into object
 - Reworked object arrangement (place on bed)
 - Accurate print time estimates for the stealth mode
 - "Remaining time to finish" feature implemented (firmware 3.3.0 or higher required)
 - Rotation & scaling of the object
 - Upgraded "out of build volume" detection
 - Improved wipe tower

[See full release log](#)
[Older versions](#)
[Cura settings](#)

HANDBOOK 3.03 May 31, 2018

[Download 3.03 \(7MB\)](#)

CHANGES IN 3.03

- Error messages (Chapter 14) added
- Nozzle change walkthrough updated
- Firmware 3.2.1 update (Linear Advance, Safety Timer, Stall guard)
- New photos (steel sheet, first layer)

MK3 handbook in the other languages:
[Čeština \(v3.03\)](#) | [Français \(v3.03\)](#) | [Deutsch \(v3.03\)](#) | [Italiano \(v3.03\)](#) | [日本語 \(v3.03\)](#) | [polski \(v3.03\)](#) | [Español \(v3.03\)](#)

[Kit assembly manual](#)
[Older versions](#)

Pict. 44 - Firmware and Drivers & Apps packages at www.prusa3d.com/drivers

To flash the firmware, connect your 3D printer to your PC using a USB 2.0 Type B cable, and then start Slic3r PE. Go to Configuration - Flash printer firmware and a new window will pop up. Check whether your printer has been correctly recognized, then click the Browse button and select the firmware file. Finally, select "Flash!" and wait for the process to finish. If everything went well, the printer will restart itself at the end of the flashing process. You can now disconnect the printer and check the firmware version in the printer's LCD menu.

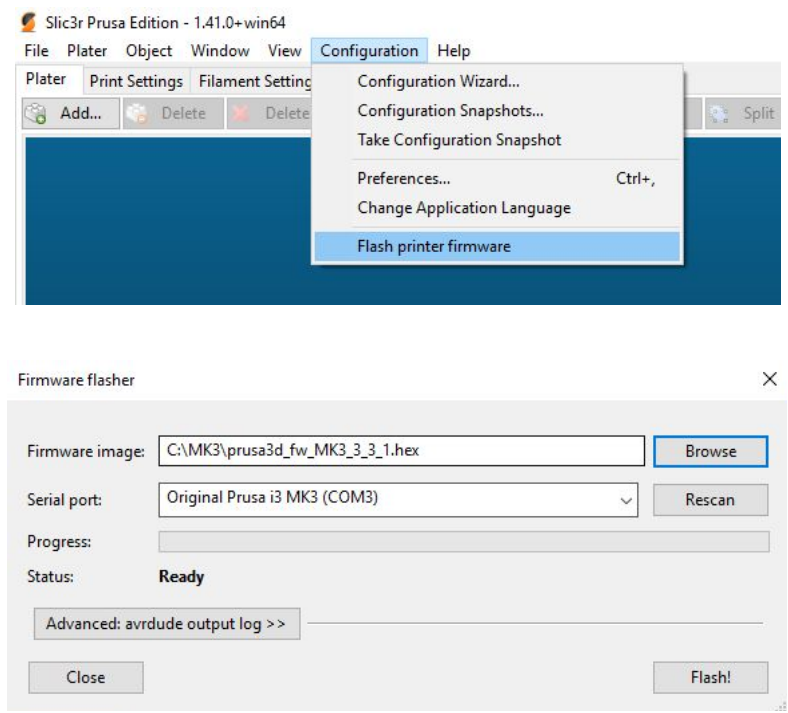

Pict. 45 - Upgrading firmware in Slic3r PE

12.10 Linearity correction

Starting with firmware 3.4.0, Linearity correction option is now available. Linearity correction is based on Trinamic stepper driver feature that allows definition of custom current-waveform. Go to **LCD Menu - Settings - Linearity correction** to adjust any of the three axes based on our tutorial article 'Extruder linearity correction calibration' at <https://help.prusa3d.com>

13 FAQ - common issues when assembling the printer kit

13.1 Printer is rocking - YZ frame - geometry check

If your printer is rocking on the table, please check Step 10 of Y axis assembly - **YZ frame - geometry check**.

All the components are cut, or drilled, by a machine for highest precision, but with uneven tightening it is possible to warp the frame.

- Using your hand, try to wiggle with the frame sides and check whether some corners are lifting up or not.
- In case you find some imperfections, release the screws, press the extrusions against the FLAT SURFACE and tighten them again.



Pict. 46 - Proper way to tighten the frame, plates and aluminium extrusion together.

13.2 Printer stops printing soon after start

Extruder is likely to be overheated. Make sure the nozzle fan is working properly. If not, please inspect its connection according to the assembly manual.

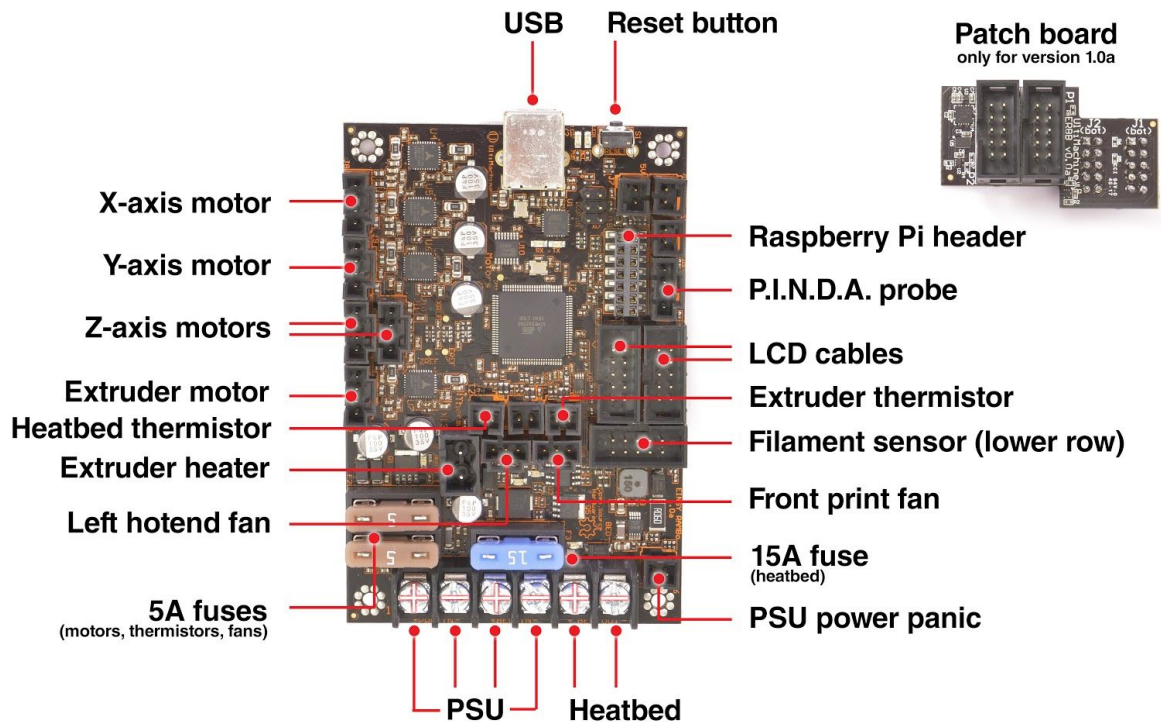

Pict. 47 - Proper wiring of the connectors

13.3 Printer can't read the SD card

First, make sure that the **file name** on the SD card **does not contain special characters** - otherwise the file could not be displayed on the LCD. If there is no error in the file name, check the EXT2 wiring (from electronics to LCD). If the cable is connected properly, try to swap the cables.

13.4 Loose X- and/or Y-axis belts

Check if both belts are properly tightened, loose belts would cause a printer malfunction and prevent proper printing. The easiest way to check is printing a round object - if any of the belts are not tightened properly the result is an irregular shape instead of a perfect circle. Y-axis belt is located under the heatbed, X-axis belt moves the extruder. See the pictures with properly tightened belts.

 You can check the belt status under **LCD Menu - Support - Belt status** after successfully running a selftest. **Values 240 +/- 40 are good.**

The belt status is a unitless number measured as an average load on the stepper motor. Lower value corresponds to higher tension (higher motor load), higher value means looser belt (less motor load).

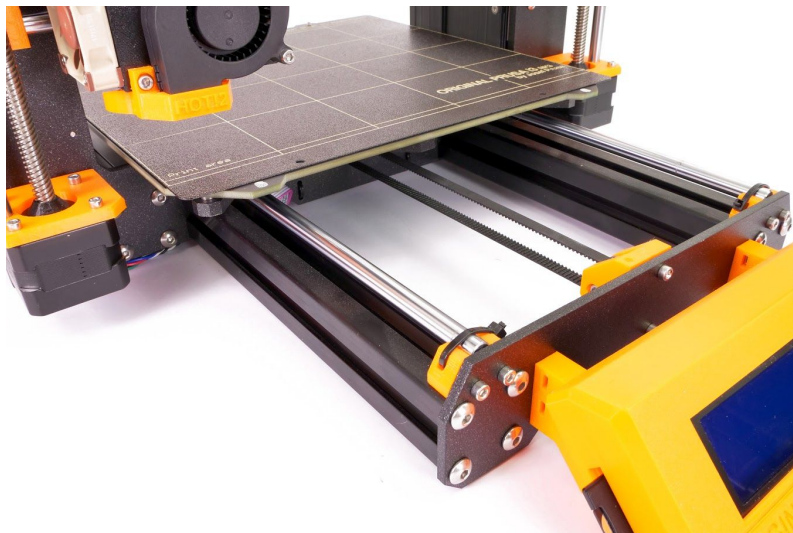

Pict. 48 - A properly-tightened Y-axis belt under the heatbed

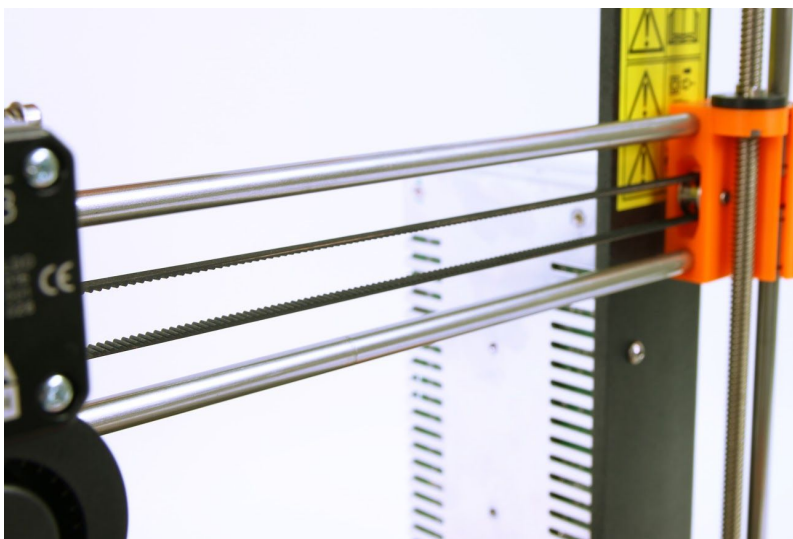

Pict. 49 - A properly-tightened X-axis belt

13.5 Cables detached from the heatbed

Do not forget to use a spiral wrap on heatbed cables and attach the cables properly so they won't restrict movement during printing.

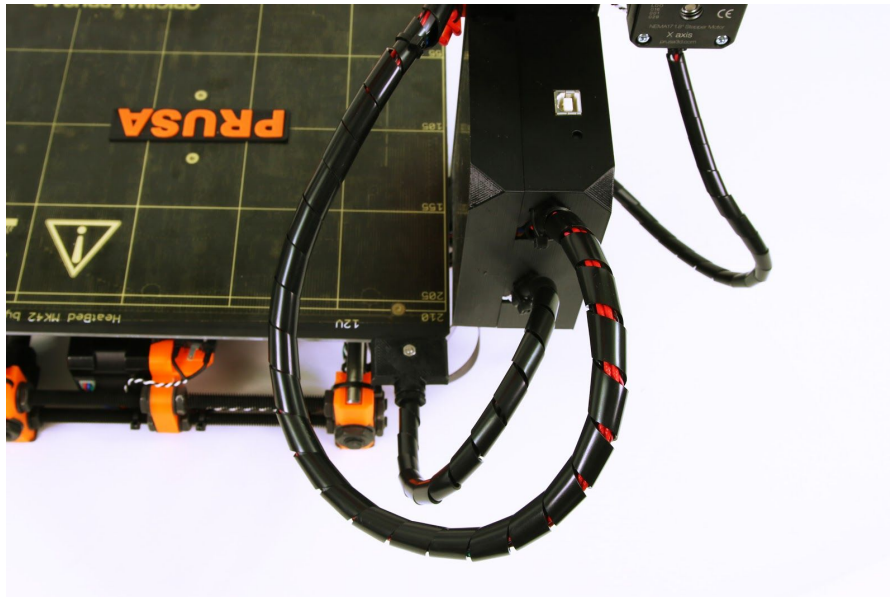

Pict. 50 - Cables should be wrapped in a spiral wrap

14. FAQ - Error messages

You can find more info about error messages and their solutions at help.prusa3d.com.

14.1 Printer has not been calibrated yet

This error message appears after the assembly of your printer or after factory resetting all data. It will remain on the main LCD screen until you successfully calibrate the printer. In order to properly calibrate your printer, follow instructions in chapter [6.3.5 Calibrate XYZ \(kit only\)](#).

14.2 Distance between the tip of the nozzle and bed surface has not been set yet

This error message occurs after you successfully finish all of the calibration parts, except for the First layer calibration. Therefore, follow the instructions in chapter [6.3.9 First layer calibration \(kit only\)](#).

14.3 Preheat the nozzle!

This error message occurs when you are loading a new filament, and the nozzle did not reach the minimum required temperature to do so.

The minimum temperature for loading a new filament is 190°C. However, it is recommended to select the actual recommended printing temperature of the material you want to load in. You can check recommended settings for each material in chapter [11 Materials](#).

14.4 MINTEMP

The MINTEMP error occurs when at least one of the temperature readouts of the hotend or the heatbed drops below 16°C. It is a safety feature which prevents the printer from overheating in case of a faulty thermistor. You should avoid having the printer near an air-conditioning unit or in a garage, where the ambient temperature might be below 16°C.

Make sure to distinguish between the **MINTEMP** error and the **MINTEMP BED** error.

- MINTEMP - problem with the hotend temperature readout
- MINTEMP BED - problem with the heatbed temperature readout

14.5 MAXTEMP

The MAXTEMP error occurs when at least one of the temperature readouts of the hotend or the heatbed is higher than 310°C. It is a safety feature which prevents the printer from overheating uncontrollably. Check if the thermistor cable is not damaged and look for overtightened zip-ties around the cables leading to the electronics board.

14.6 Thermal runaway

The 'Thermal runaway error' occurs when the temperature readout of the hotend drops by 15°C for more than 45 seconds or heatbed for more than 4 minutes while printing. It is a safety feature which prevents the heater from reaching dangerously high temperatures if the thermistor becomes loose. It can also happen when you have the printer near an air-conditioning unit or an open window. We have described more troubleshooting options at help.prusa3d.com.

14.7 Preheat error

The Preheat error message occurs when there is a problem with the preheat process. Which usually means that there is something preventing the printer from heating up in proper time. You should check whether your hotend or heatbed thermistors are properly seated. We have described more troubleshooting options at help.prusa3d.com.

14.8 File incomplete. Continue anyway?

This error message occurs when there is a problem with the generated G-code and it could potentially fail the whole print. The printer automatically looks for the command M84 (disable motors) in the end section of a g-code file. If it's not detected, you will get a warning. You can still continue printing if you wish, but you should probably examine the file. Files generated by vast majority of slicers should be OK with this control, but you may experience

problems with some less common software. We are recommending using Slic3r PE or Prusa Control.

14.9 PRINT FAN ERROR

PRINT FAN ERROR error message occurs when the print fan does not receive any RPM (Revolutions per Minute) readings. In other words, there is something preventing it from spinning. Check the fan for any plastic debris and clean it if necessary. Also, make sure that the fan is properly plugged into the electronics and that the cable is undamaged.

14.10 EXTR. FAN ERROR

The EXTR. FAN ERROR message appears when the extruder fan does not receive any RPM (Revolutions per Minute) readings. In other words, there is something preventing it from spinning. Check the fan for any plastic debris and clean it if necessary. Also, make sure that the fan is properly plugged into the electronics board and that the cable is undamaged.

14.11 Blackout occurred. Recover print?

This error message' appears if the power goes off for a longer period of time during printing, and the hotend and heatbed already cooled down. The printer will wait for your input. Check if the object is still attached to the heatbed and then you can safely resume the print.

14.12 Please open the idler and remove the filament manually

This error message occurs when the automatic filament unloading process did not work properly and you need to remove the filament manually. Follow our guide at help.prusa3d.com to fix this issue.

14.13 Static memory has been overwritten

This error message should not appear on our official firmware releases as these have already gone through our testing. However, it can appear in self- or community-built firmware versions. The easiest solution is to flash in an official firmware [12.9 Updating printer firmware](#).

Print and share!

Do not forget to tag your prints with #prusai3mk3 while sharing so we can find, pin and showcase them with our

Pinterest

<http://www.prusa3d.com/original-prusa-i3-prints/>

Happy Printing :)